

H.S. Anead

Electromechanical Engineering
Department, University of
Technology Baghdad, Iraq.
hoshams.2000@yahoo.com

K.F. Sultan

Electromechanical Engineering
Department,
University of Technology
Baghdad, Iraq.
ksultan61@yahoo.com

M.S. Abdl Ghafoor

Electromechanical Engineering
Department, University of
Technology Baghdad, Iraq.
thehero.heart@yahoo.com

Received on: 21/08/2016
Accepted on: 08/06/2017

Controlling for Boiler in Thermal Power Plants by Using Fuzzy Logic Controller

Abstract- Presently used modern techniques to control instead of the traditional control techniques for many industrial applications virtually or theoretically. In this research, a Fuzzy logic has been applied to control the important variables of steam generator in AL Dura station in Baghdad that generate (160 MW). These controlled variables are pressure, temperature, air fuel ratio, lower water level, flame and gas. Fuzzy requires a data, which obtained from actual power plant. This work explains the control on two stages during operation boiler and after operation boiler in order to make a right decision if any faults occurred during these stages at limit conditions based on fuzzy system. It was used simulation of Fuzzy system in MATLAB program. The results showed that the adoption of control technique that based on Fuzzy logic have a high response to indicate the control signals and thus can be depended as an active control system for selecting a right decisions compared with traditional systems. The adoption of fuzzy logic in control system gave the ability to take on decision for control signals with a high stability compared with traditional methods. The fuzzy system contributed in giving prophesies for station case to tell the operator what to do therefore enhancement the performance of station through to take a right decision to avoid stopping. The adoption of mfs in term (trapezoidal) showed a big corresponds with the proposed system and that is through a rapid response. The enhancement of efficiency was 10% when using fuzzy system. The accuracy of fuzzy in control was 0.99 that gave the ability to take on decision for control signals with a high stability compared with traditional methods.

Keywords- Fuzzy logic controller, boiler, flame and gas, air fuel ratio, water level

How to cite this article: H.S. Anead, K.F. Sultan., and M.S. abdl Ghafoor, "Controlling for Boiler in Thermal Power Plants by Using Fuzzy Logic Controller," *Engineering and Technology Journal*, Vol. 35, Part A. No. 7, pp. 717-724, 2017.

1. Introduction

Much of the electricity used in our countries is produced by steam power stations. Thermal power stations contribute about 65% of the power supply in the world. However, electric energy is produce from some other sources such as hydropower, gas power, solar power, biogas power etc. Recently, the efficiency of this type of the stations is low despite efforts to develop energy converters. In order to get the demand of electrical power; the turbine requires an analogous amount of thermal power as well as this minimizing the losses leads to a decrease of pollutions [1]. Now there is a modern technique called Fuzzy logic controller for improving the performance of boiler to increase the efficiency and productivity of power. Fuzzy logic represents soft computing method for solving problems where classical logic cannot provide satisfying results. Fuzzy logic is multi-value logic derived from theory of fuzzy sets proposed by Zadeh (1965). This kind of logic gained success because it makes use of the tolerance for imprecision and uncertainty to achieve tractability, robustness, and low cost solution [2]. The fuzzy theory gives a mechanism linguistic constructs such as "many," "medium," "low," "often," "few." In general, the fuzzy logic can be able to

understand human reasoning. Fuzzy Logic Controller (FLC) has faster and smoother response than proportional integrated Derivative (PID) conventional systems and control complexity is less [3].

In this research Fuzzy interface system can use in Matlab program with M – file for controlling of boiler in thermal power plants provides a correct conditions to operator once happen any problem throughout the operation.

2. Description of the Problem

A steam turbine plant of type (K-160-13.34-0.0068) used in this work. This type consists of three stages high pressure, intermediated pressure and lower pressure turbines. As well as, the system includes bleeding extractions, feed water heaters and other supplementary system. A boiler is an enclosed vessel, which is considered steam generator by, provides a heat of combustion to be transferred on to the water. Water is heated to become superheated steam. The combustion depends on the quality of fuel used and excess air. The high pressure makes the size of steam reach to 1,600 times and thus produces force very large appropriate to rotate the blades of turbine. This makes the boiler equipment that require more care.

Steam output of the boiler is superheated steam at a temperature of 535°C and 13.34MPa pressure enters to the HPT section. The boiler room of standard is indicated in the Figure 1 [4].

3. System Configuration

In this study, Fuzzy logic system is applied to control the boiler and turbine. As stated previously that the system uses fuzzy linguistic expressions instead of the numbers shows the status of system to take the right option. Fuzzy Inference System includes fuzzification that involves input of variables as a membership function. Defuzzification is the other part from FIS that involve output of variables. The third section determines the principles of system that fixing variables for improving control system [5] as shown in Figure 2.

4. Fuzzy Simulation

In this study, the control of parameters, which effect on boiler is simulated using MATLAB and M – file program according to structure control language that has been obtained within the operating limitations. Based on data obtained from actual station, fuzzy system was built to control important variables for the boiler in the thermal power plant. This system consists of (6 input) of variables, (2 outputs) for operating status and rules of control, these construct was explained by using MATLAB program as shown in Figure 3.

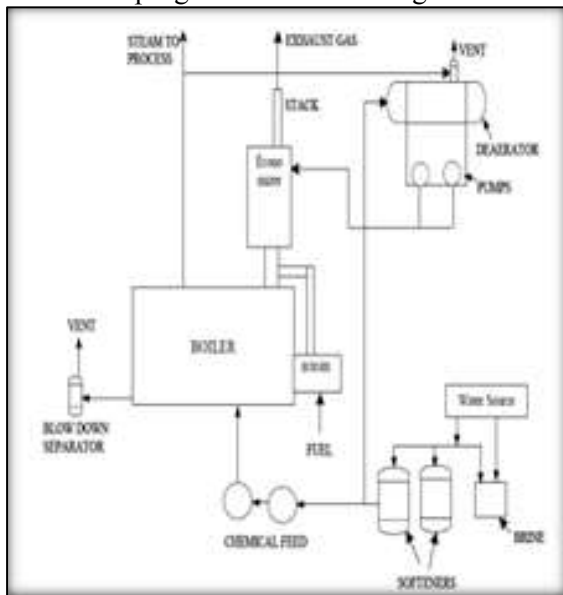

Figure 1: The graphs of boiler drum [4]

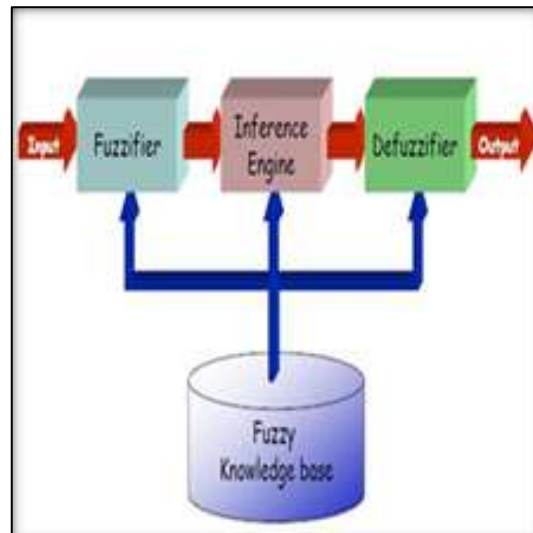

Figure 2: Graph of FIS [6]

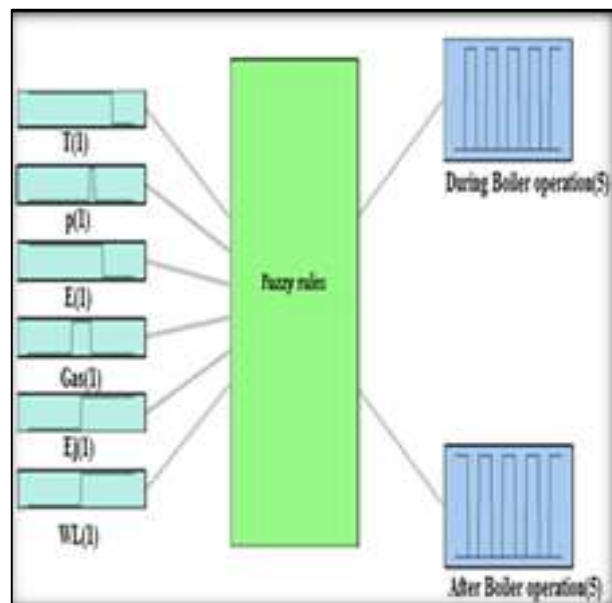

Figure 3: Fuzzy controller 6 input, 2 output, 12 rules

5. Input Variables of Fuzzy Construct

There are many variables that affect the operation of the station; are 8 inputs which discussed as follows:

A. Temperature input variable

Temperature generated from the boiler is show that the temperature should be less than 550°C to avoid damage .Therefore fuzzy applied in this limit as explained in Figure 4. A safety operation of the steam temperature before reaching the maximum peak to avoid the fault before it occurs.

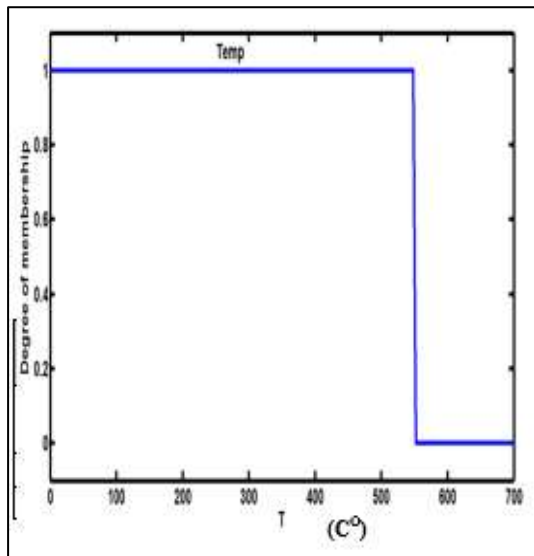

Figure 4: Input membership function of temperature (T)

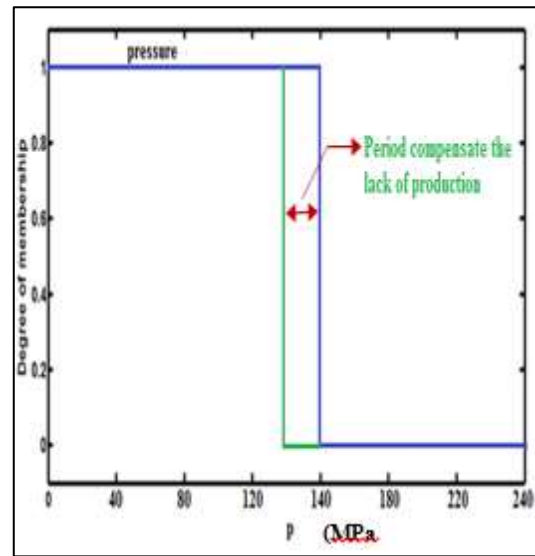

Figure 5: Input membership function of pressure (p)

B. Pressure input variable

After obtaining the actual values of the station, it found that the proper pressure for boiler is less than 140 MPa so it was employing fuzzy logic on that basis. This period is that the initial operation period at that the boiler is prepared to require advantage of the steam product. As shown in Figure 5.

C. Air fuel ratio input variable

This ratio represents amount of air, which reacts to the amount of fuel in the combustion chamber. It considered the main factor of combustion that occurs in the furnace. If the mixture is, poor this means the emergence of CO in the products and this causes losses in the heat, this process called incomplete reaction. While if the mixture is a rich that refers to generate CO₂ in the products and this process called complete reaction [7]. Excess air very necessary to gets rid of heat loss and make the reactions complete. In order to calculate the percentage of excess air uses the formula as follows:

$$\text{Excess Air} = K \left[\frac{21}{21 - \% \text{ Oxygen}} \right] \times 100\% \quad (1)$$

Where: k is constant and equal to (0.9 for gas, 0.94 for oil and 0.97 for coal). For various fuels used in these reactions, Table 1 explains the excess air that needed at full capacity as follows [7]:

The appropriate value of air fuel ratio (E) in the combustion reactions which controlled by fuzzy logic controller approximately 14 to provide a right heat for heating water with a required value. FLC has been applied as shown in Figure 6.

Table 1: Excess air required at full capacity

Fuel Type	%Oxygen in flue gas	%Excess air minimum
Natural gas	1.5 – 3	7 – 5
Fuel oil	0.6 – 3	3 – 15
Coal	4.0 – 6.5	25 – 40

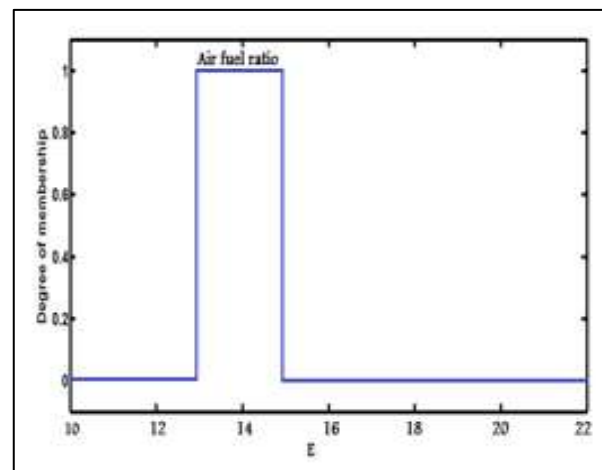

Figure 6 Input membership function of air fuel ratio (E)

D. Gas input variable

Fuzzy logic was used due to the need for the presence of gas after boiler operation to ensure the continuation of flame. So the number has been chosen for gas presence is (0.1) that represents almost (1–2 sec) and this value considered ideal practical value to implement the flame. Thus, it has been achieved a very safe ignition. As shown in Figure 7.

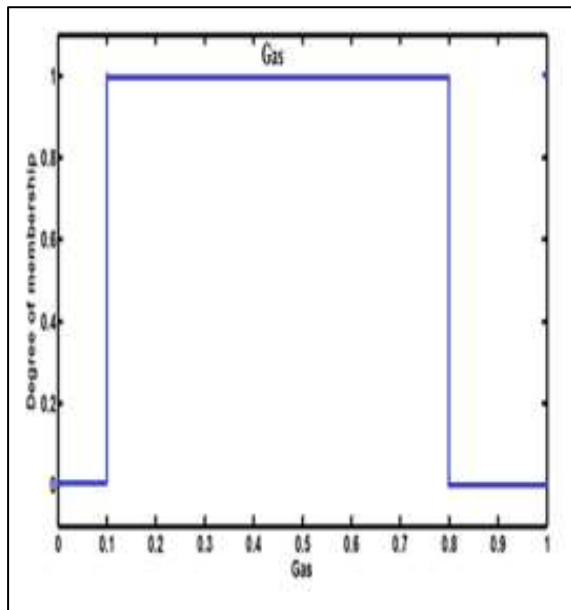

Figure 7: Input membership function of Gas

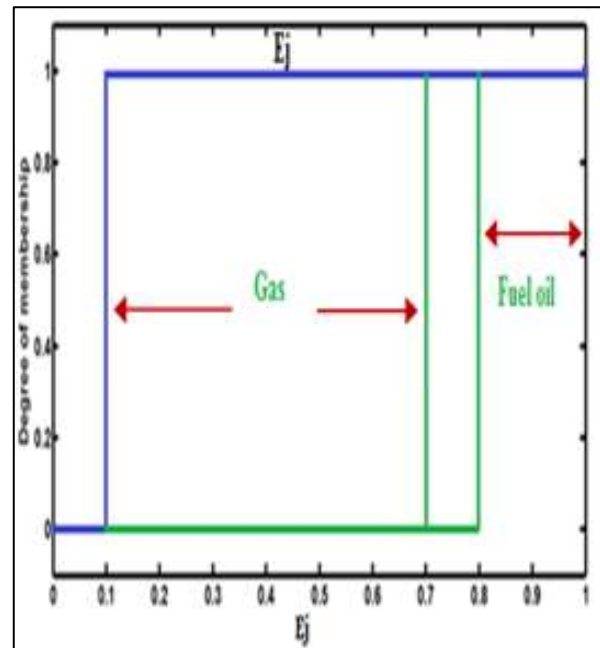

Figure 8: Input membership function of flame

E. Flame input variable

Fuzzy has been applied to make sure found after running the boiler as shown in Figure 8. The flame is generated after the spark ignition and opens the gas. In order to reduce gas consumption, the formation of flame by gas is (0.7) and then uses fuel oil. The flame quality depends on air fuel ratio during combustion in furnace [8].

F. Lower water level input variable

Gauge glass is responsible for the water in the boiler drum. Lower level of water causes sediment, salt, and corrosion, so used fuzzy logic to control on the level as shown in Figure 9. Which gives a warning if the level is few to take the appropriate decision. The water level inside the boiler drum needs to be controlled because the demand of changing loads [9]. Boiler operation depends on the amount of water, which find inside the boiler. Water level is one of operating conditions has been adopted because of its importance to improve the performance. Where the period (0–0.8) [9] represents extinguished state the boiler not be allowed to work in this period to ensure the improvement process from side the fuel consumption and production quality. while the period (0.8 – 0.95) [9], represents turn on boiler in which ensure optimization process and the water pump is on ,where after this period the water pump is off and boiler has been filled with a right level of water.

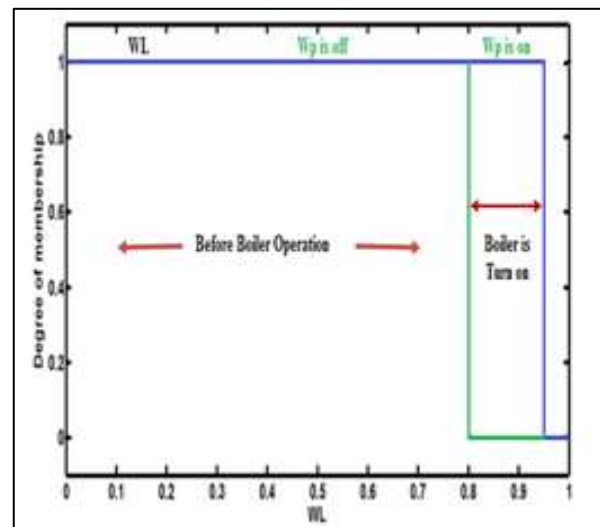

Figure 9: Input membership function of Lower water level (WL)

6. Output of Fuzzy Construct

The outputs of Fuzzy inference system have been contained two cases with its conditions such as during operation boiler and after operation boiler status. As shown in Figure 10 and Figure 11, these explain the checking process to avoid any problem that may occur. These figures have been obtained from M – file program in MATLAB after simulation.

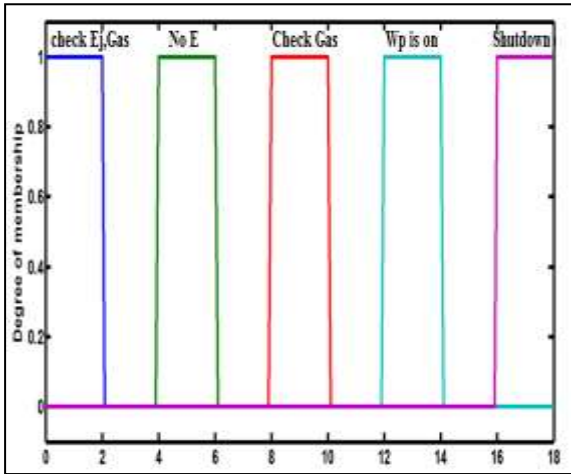

Figure 10: The output of FIS during boiler operation

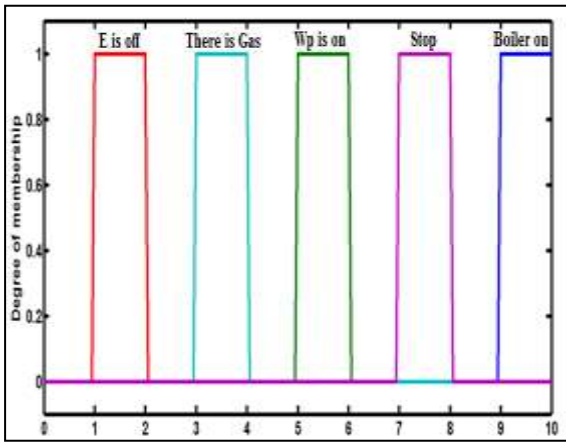

Figure 11: The output of FIS after boiler operation

7. Result and Discussion

The fuzzy system for boiler variables is simulated using MATLAB and too verified by using M – file Program as indicated in Figure 12. Membership functions are subject to a 12 rules during the procedure, which included the If – then method, which based on the limit conditions for the work of the boiler for the purpose of control [10], as shown in Figure 13. This method can be expressed by using general formula as follows [10 – 17]:

If x_1 is A_1 and x_n is A_n , then $y = f(x_1, x_2, x_n)$ (2)

Where: x and y are linguistic variables. The section " x is A " is called premise part, while section " y is B " is called conclusion part. A and B represent the linguistic value. The value for which the zone under the graph line of the membership functions is divided with equally. This procedure is called a center of gravity defuzzification process as shown in Figure 14. The efficiency of FIS depends on the process of defuzzification and type of input mfs. However, the variables of mfs and area can be adjusted to enhance efficiency of the whole system.

Table 2 explains the range of values for each variable that obtained from experts in the plant

.This table called decision table, which give different case for system variables in order to show operator what is optimum case for operation. Scale has been taken for variables.

The results showed matching occurrence up to 0.95 with theoretical results so this explains possible adoption in practice. The results showed that the adoption of control technique that based on Fuzzy logic have a high response to indicate the control signals and thus can be depended as an active control system for selecting a right decisions compared with traditional systems. The adoption of fuzzy logic in control system gave the ability to take on decision for control signals with a high stability compared with traditional methods. The fuzzy system contributed in giving prophesies for station case to tell the operator what to do therefore enhancement the performance of station through to take a right decision to avoid stopping.

```

1  clc
2  close all
3  fis = readfis('v91.fis');
4  P=[130 140 150];
5  T=[500 550 600];
6  H=[0.195 0.12 0.13];
7  W=[3010 3020 3100];
8  E=[13 14 15];
9  WL=[0.95 0.25 0.25];
10 Gas=[0.09 0.5 0.5];
11 Eg=[0.95 0.75 0.75];
12 %AA= [143 630.7 0.1411 3200.2 15 0.0 0.1 0.7];
13
14
15
16 for MI=1:3,
17     disp('*****')
18     disp(['Case : ' num2str(MI)])
19
20 out=evalfis([P(MI) T(MI) H(MI) W(MI) E(ME) WL(ME)
21             Gas(MI) Eg(MI)],fis);
22
23
24 % During Boiler Operation
25 Demout(1);

```

```

26
27 % During Boiler Operation
28 Demout(1);
29
30 if Dem=1 && Dec=2
31     During_status='E is OFF';
32
33 else
34     if Dem=3 && Dec=4
35         During_status='There is GAS';
36     else
37         if Dem=6 && Dec=6
38             During_status='Wp is On';
39         else
40             if Dem=10 && Dec=12
41                 During_status='stop';
42             else
43                 During_status='Turn on Boiler';
44             end
45         end
46     end
47 end

```

Figure 12: Shown the M – file programming

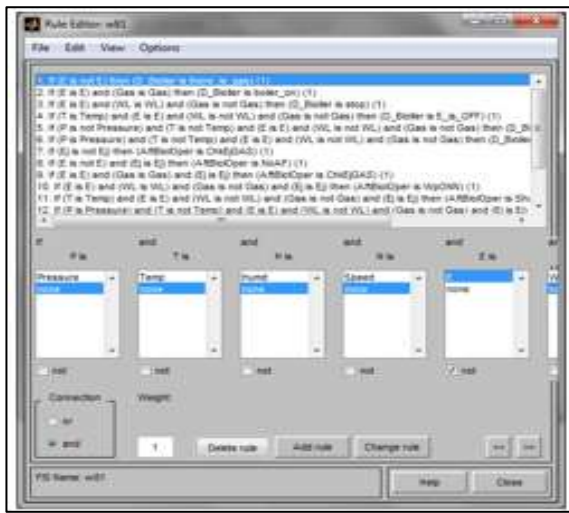

Figure 13: Fuzzy rules for input and output relationship



Figure 14 Center of gravity defuzzification method

The adoption of mfs in term (trapezoidal) showed a big corresponds with the proposed system and that is through a rapid response. The enhancement of efficiency was 10% when using fuzzy system. The accuracy of fuzzy in control was 0.99 that gave the ability to take on decision for control signals with a high stability compared with traditional methods. Figure 15 and 16 represents the surface of (Gas and E) before boiler operation. Most of the previous studies included simulation of fuzzy logic using computer programs with the traditional PID method and compared the results between them, in this paper use the technique of fuzzy logic with MATLAB program Simulink to control 6 variables for boiler. The Software has two sections the first is the algorithm while the second is the flow chart. Program was written by the use of Matlab version (2014a) in m.file. At the primary part of the procedure, deep data of the system behavior is usually needed. Therefore, the initial step is to analysis and to

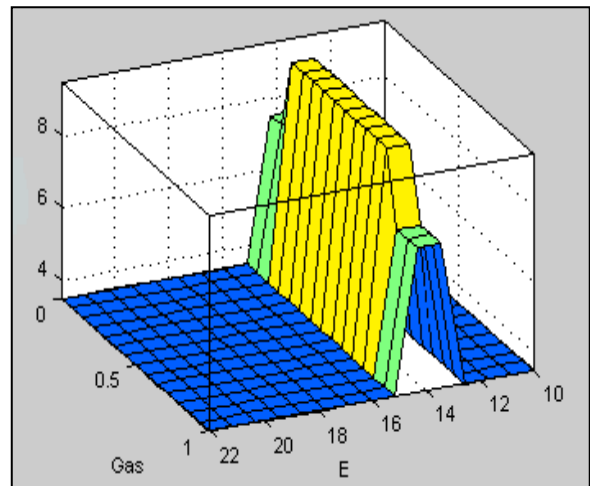

Figure 15: The surface view of Gas and E before operation

research the behavior health of the machine. For learning this behavior of assorted indicators, that are associated with the error to be discovered, are calculated in smart state. The formula is dead on actual data that is representing an explosive abnormality to diagnose it.

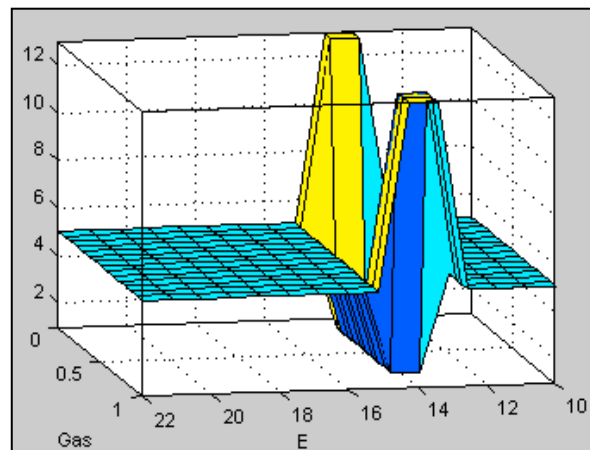

Figure 16: The surface view of Gas and E after operation

Implementation of the algorithm for error detection correctly and completely isolated. The proposed algorithm for the purpose of control is composed of two parts:

The first part: deals with the data from the boiler before operation. This data relate to air fuel ratio, water level, the quantity of gas, temperature and pressure. After obtaining the data it is examined in order to increase efficiency and avoid problems, in the case of incorrect of the planned values, consequently, the boiler can't be working, thus should verify the error and repair, then come to urge the knowledge from the boiler.

The second part: Is the monitors of boiler operation during its work within the framework of

an infinite loop which follow the flame, gas, air fuel ratio, water level, temperature and pressure.

Table (2) Decision table for boiler system

Variables Decision	Weights				
	L ⁺	L	M	H	H ⁺
Pressure P(bar)	(1.1 ,1.2) Stop Boi.	(1.2 , 1.3) Inc. p	(1.3 , 1.4) Steady state	(1.49 , 1.5) Dec. P	(1.5 , 1.6) Stop Boi.
Temperature T(°C)	(5 ,5.2) Stop Boi.	(5.2 , 5.3) Inc.T	(5.3 , 5.5) Good values	(5.5 , 5.7) Dec.T	(5.7 , 6) Stop Boi.
Air fuel ratio E	(1.1,1.2) Check E	(1.2 , 1.3) Check E	(1.3 , 1.5) Good values	(1.5 , 1.6) Check E	(1.6 , 1.7) Check E
Water level (W _L)	(0.1 , 0.4) Boi. Is off	(0.4 , 0.8) Wp is on	(0.8 , 0.95) Boi. is on	(0.95 , 0.99) Wp is off	(0.99 , 1) Boi. is off
Gas input GAS	(0.1 , 0.2) There is gas	(0.2 , 0.3) There is gas	(0.3 , 0.7) Steady state	(0.7 , 0.8) Gas is off	(0.8 , 0.9) Gas is off
Flame input E _j	(0.1 , 0.2) There is E _j	(0.2 , 0.3) There is E _j	(0.4 , 0.8) There is E _j	(0.8 , 0.85) There is E _j	(0.85 , 0.9) There is E _j

on Energy and Environment,” [Bulgaria](#), P.608-611, March 19-21, 2009.

8. Conclusion

The present research for fuzzy simulation gave the following conclusions:

1. The results showed matching occurrence up to 0.95 with theoretical results so this explains possible adoption in practice.
2. The results showed that the adoption of control technique that based on Fuzzy logic have a high response to indicate the control signals and thus can be depended as an active control system for selecting a right decisions compared with traditional systems.
3. The adoption of fuzzy logic in control system gave the ability to take on decision for control signals with a high stability compared with traditional methods.
4. The fuzzy system contributed in giving prophesies for station case to tell the operator what to do therefore enhancement the performance of station through to take a right decision to avoid stopping.
5. The adoption of mfs in term (trapezoidal) showed a big corresponds with the proposed system and that is through a rapid response.
6. The enhancement of efficiency was 10% when using fuzzy system. As well as the accuracy of fuzzy in control was 0.99 that gave the ability to take on decision for control signals with a high stability compared with traditional methods.

Reference

[1] R. Kumar, S. Kaushik and A. Kumar, “Energy and Energy Analysis of Non – reheat Thermal Power Plant, Proceedings of International Conference

[2] L. Zadeh, “Soft computing and fuzzy logic,” IEEE Software 116 (1994) str. 48 56.
 [3] J. Cheung and A. Kamal. “Fuzzy Logic Control of refrigerant flow,” UKACC International Conference on Control, 96, Conference Publication No. 427, 2 – 5, [Bulgaria](#), September 1996.
 [4] Energy Efficiency Guide for Industry in Asia, “Thermal Energy Equipment boilers & thermic fluid heaters,” UNEP. United Nations Environment Programme 2006. www.energyefficiencyasia.org
 [5] Surachai Panich. “Development of Fuzzy Controller for Water Level in Stream Boiler Tank,” Journal of Computer Science 6 (11): 1233 – 1236, 2010.
 [6] Anabik Shome, “Fuzzy Logic Approach for Boiler Temperature & Water Level Control,” International Journal of Scientific, Volume 3, Issue 6. ISSN 2229-5518. June – 2012.
 [7] H. Santoso, Y. Nazaruddin and F. Muchtadi. “Boiler performance optimization using Fuzzy logic controller,” Jl. Ganesa No. 10, Bandung 40132, Indonesia.2006.
 [8] V. Galzina, and R. Lujic.” Application of fuzzy logic in boiler control,” Technical Gazette ISSN 1330 – 3651, 2008.

- [9] A.C. Rabah, "Improved Controller for a thermal power plant," Institute de Genie Electrique, India, 2012.
- [10] T.J. Kerschbaum. "Advanced controls- fuzzy logic for fluidized bed boiler," AT&P journal PLUS2 2008.
- [11] H. Bentarzi, R. Amr and N. Mastorakis. "A new approach Applied to a Thermal Power Plant Controller Using Fuzzy Logic," ISSN: 1790-1979, Issue 9, Volume 6, September 2009.
- [12] I. Kocaarslan, E. Cam, and H. Tiryaki. "An Investigation Of Productivity In Boilers Of Thermal Power Plants With Fuzzy Gain Scheduled PI Controller "Electricity Generation Company Inc, Ankara, 06490, Turkey.Vol.2, No.1, January 2010
- [13] Surachai Panich, "Development of Fuzzy Controller for Water Level in Stream Boiler Tank," Journal of Computer Science 6 (11): 1233 – 1236, 2010
- [14] P. Meenu and G. Priya, "Fuzzy Logic based Boiler drum Level Control and Protection system," Methods Enriching Power and Energy Development (MEPED), ISSN: 2279-0500, 2014.
- [15] C.B. Kadu , D.V. Sakhare, "Improved Inverse Response of Boiler Drum Level using Fuzzy Self Adaptive PID Controller," Volume 19 Number 3 – Jan ISSN: 2231– India 2015
- [16] J.A. Oyekale. "Performance Modeling of Steam Turbine Performance using Fuzzy Logic Membership Functions," Vol .19 (1) 109-115, ISSN 1119-8362, March 2015.
- [17] S. Anitha, R. Lakshmi Priya, and R. Mahalakshmi, "Fuzzy Logic Based Boiler Drum Level Control in Power Plant," India, Vol. 5 Issue 2 ISSN: 2278-621X, March 2015.

Electro Mechanical Engineering, University of Technology, Baghdad, Iraq, Electromechanical. Eng. Dept. Born in Iraq on 19th march 1994, Completed Bachelor of Engineering (Mechanical Engineering) in the year of 2014 and completed Master of Engineering (Thermal Engineering) in the year of 2017. His research area is energy and renewable energy.

Email: thehero.heart@yahoo.com

Nomenclature

FIs	Fuzzy inference system	–
mfs	Membership functions	–
FLC	Fuzzy logic controller	–
H	Humidity	–
T	Temperature	^o C
P	Pressure	bar
N	Speed	rpm
L ⁺	Very low	–
L	Low	–
M	Medium	–
H	High	–
H ⁺	Very high	–

Author(s) biography



Asst. Prof. Dr. Hosham S. Anead. Head of Department of Electromechanical. Eng. University of Technology, Baghdad, Iraq. Born in Iraq on 20th march 1972. Completed Bachelor of Electrical Engineering in the year of 1996

and completed Master and PhD of communication engineering in the year of 1999 and 2002. His research area is spread spectrum, cellular network, MIMO, power electronic, and thermal power plant. **E-mail:** hoshams.2000@yahoo.com,



Lect. Dr. Khalid F. Sultan, University of Technology, Baghdad, Iraq, Electromechanical. Eng. Dept. Born in Iraq on 19th march 1971, Completed Bachelor of Mechanical Engineering in the year of 1996 and completed

Master and Ph of Engineering (Thermal Engineering) in the year of 2004 and 2012. His research area is heat transfer enhancement and renewable energy by using nano fluids. **E-mail:** ksultan61@yahoo.com



Mohammed Salam. Abdl Ghafoor, Student master in