



Impact of Distributed Generation on a Distribution Network Voltage Sags in Baghdad City

Ali H. Mohammed ^{a*}, Suad I. Shahl ^b

^aElectrical Engineering Department, University of Technology, Baghdad, Iraq,
30274@student.uotechnology.edu.iq

^bElectrical Engineering Department, University of Technology, Baghdad, Iraq,
Suad.I.Shahl@uotechnology.edu.iq

*Corresponding author.

Submitted: 09/09/2020

Accepted: 22/12/2020

Published: 25/04/2021

KEY WORDS

Differential evaluation algorithm,
Distributed generation,
Distribution network.
Power quality,
Voltage sag.

ABSTRACT

Voltage sags are considered as one of the most detrimental power quality (PQ) disturbance due to their costly influence on sensitive loads. This paper investigates the voltage sag mitigation in distribution network following the occurrence of a fault. Two software are used in this work; the 1st is MATLAB R2017a for implementation of the Differential Evaluation (DE) algorithm to find the optimal location and size DG and while the 2nd software is CYME 7.1 for the distribution system modelling and analysis. The effectiveness of the proposed method is tested by implementing it on IEEE 33-bus system, and then it is applied to Al-Masbh distribution network in Baghdad city as a case study. The paper aims to enhance voltage profile, power loss reduction, and relieve distribution lines overloading, by optimal placement of distributed generation (DG). The results indicate the efficiency of the proposed method comparing with Real Coded Genetic Algorithm (RCGA).

How to cite this article: Ali Hadi Mohammed, Suad Ibrahim Shahl, "Impact of Distributed Generation on a Distribution Network Voltage Sags in Baghdad City," Engineering and Technology Journal, Vol. 39, Part A, No. 04, pp. 528-542, 2021.
DOI: <https://doi.org/10.30684/etj.v39i4A.1828>

This is an open access article under the CC BY 4.0 license <http://creativecommons.org/licenses/by/4.0>

1. Introduction

PQ can be defined as the capability of utilities to provide electric power with no interruption. One of the serious PQ problems is voltage sag [1].

Voltage sag is a temporary decrease in voltage for a short period of time, followed by restoration of the voltage to its normal value. This is related to the appearance and clearance of a fault current or

other excess currents in the power system [2]. Application of DG in the distribution network is expected to mitigate the voltage sag. DG is a compact electrical power source that is connected directly to the distribution network or at a location closer to customers [3, 4].

In [5], developed the optimal DG placement method to enhance both PQ and power losses of a distribution network. Voltage sag as a PQ issue is investigated by researchers based on the reliability indices that associated with event time, sag cost and sag energy. The system reliability indices illustrated the impact of voltage sags on customers and system. Test system results have explained the performance of the presented model to find the optimal DG placement.

In [6], suggested an Artificial Bee Colony (ABC) algorithm to find the optimal size and location of DG units by loss sensitivity index to reduce the real power loss, total harmonic distortion (THD) and voltage sag index improvement in a radial distribution network. The results of the proposed method presented that the appropriate location of DG minimizes real power loss, THD, voltage sag and voltage profile improvement. In [7], applied Particle Swarm Optimization (PSO) to find the optimal number, allocation, and size of DGs to minimize the voltage sag and the voltage deviation reduction. The results showed by installing DGs, the system power loss had been minimized as well as the improvement of the voltage profile. PSO could be a good alternative approach for solving such optimization problems that capable to find the optimal DG allocation on a distribution network.

In [8], presented an approach for optimal allocation of DG units in distribution system with the traditional PSO technique. The paper indicates the voltage sag consideration importance in the optimum allocation problem of DG units and some effects of DGs installation on the distribution system. These impacts were studied in both normal steady-state condition (line power losses) and abnormal durations (voltage sag losses). In [9], introduced a new methodology employing RCGA for the situation of DG in the radial distribution systems to decrease real power losses and to get better the voltage profile.

In this paper used DE algorithm in MATLAB on the network study to find the optimal location and size of DG and study effect of DG on voltage sag in the network.

In part 2 explained voltage sag definition, description, causes, determination, and effect of adding DG. In part 3 explained mathematical modeling of load flow analysis, RCGA and DE algorithm. In part 4 explained the results of the work on IEEE 33-bus and Al-Masbh network as examples of the application of the DE algorithm. In part 5 made comparison with results of [9] to show efficiency of DE algorithm to determine the optimal location and size DG to get lower voltage sag. Then in part 6 made the conclusion. At last, the references.

2. Voltage sag

Definition various PQ problems can be classified as swells, sags, transients, harmonics, and unbalance are considered are the most common problems in electrical distribution systems. These types of PQ disturbances can cause equipment malfunctions, increasing the likelihood of a power outage [10]. Among these, voltage sags represent the highest percentage of appearance in equipment interruptions, as shown in Table I.

TABLE I: PQ problems [1]

PQ problem	Percentage (%)
Asymmetrical voltage	18
Harmonics	18
Shout outage	13
Voltage transients	8
Voltage sag	31
Voltage swell	13

The Institute of Electrical and Electronics Engineers (IEEE) defines voltage sag as reduce in RMS voltage between 0.1 per unit (p.u.) and 0.9 p.u. for a time from 0.5 cycles to 1 min. The International Electrotechnical Commission (IEC) defines voltage dip as a sudden decrease of the voltage at a point in the electrical system, followed by a voltage restore after a short duration of time,

from half a cycle to a few seconds [11]. Voltage sag in American English is also known as voltage dip in British English, both having the same meaning. The magnitude of the voltage sag is measured as a per unit (p.u.) or percentage (%) of the rated voltage [12]. Voltage sag to 50% is equivalent to 50% of nominal voltage. However, special attention should be paid when talking about the magnitude of the voltage sag. For example, 30% sag can refer to sag that resulted in a voltage of 30% or 70%, as this can be either remaining (retained) voltage or the missing (drop) voltage. In most of the literature, the residual voltage measurement is the amount of voltage sag as shown in Figure 1.

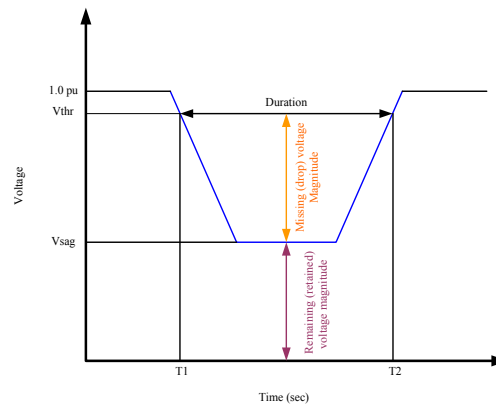

Figure 1: Voltage sag with both drop and retained voltages

I. Voltage sag description

A typical example of voltage sag is shown in Figure 1 that shows the sag as a residual voltage magnitude. Voltage sag begins when the voltage falls to a voltage below threshold voltage V_{thr} (0.9 p.u.) at time T_1 , the lower voltage continues until T_2 , at T_2 the voltage restores to a value slightly above V_{thr} . The voltage sag magnitude is V_{sag} and its interval is $(T_2 - T_1)$ [11].

II. Voltage sag causes

The major common of voltage sag causes are [13]:

- 1) The short-circuit currents
Although the short-circuit current will be quickly removed by the fuse or circuit breaker, the voltage will drop until the protection device operation, which can take anywhere from a few cycles to a few seconds.
- 2) The heavy loads starting currents
Such as an induction motor or heater loads. Electric motors typically draw 150% to 500% of their operating current as they come up to speed. Resistive heaters typically draw 150% of their rated current until they warm up.
- 3) The power transformers inrush current
 - 3.1 Energizing action
The cause for voltage sags due to transformer energizing is normal system operation, which includes manual energizing of a transformer. The voltage sags are unsymmetrical in nature, often depicted as a sudden drop in system voltage followed by a slow recovery. The main reason for transformer energizing is the over-fluxing of the transformer core which leads to saturation.
 - 3.2 Reclosing action
For long duration voltage sags, more transformers are driven into saturation. This is called Sympathetic Interaction.

III. Voltage sag determination

The essential point of voltage sag determination is short circuit analysis. To measure the voltage sag in a node in the radial distribution system, the voltage divider model shown in Figure 2 is used.

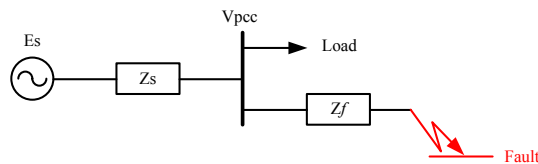

Figure 2: Voltage divider model for voltage sag [14]

The sag magnitude at the load can be calculated as follows:

$$V_{pcc} = V_{sag} = E_s \frac{Z_f}{Z_s + Z_f} \quad (1)$$

Where

E_s : is the source voltage.

V_{sag} : is the sag voltage due to fault at a point of common coupling (PCC).

Z_s : is the impedance of source.

Z_f : is the fault impedance between PCC and point of fault.

Increasing the distance between the fault location and power system bus can reduce the voltage sag. So, from Eq. (1), voltage sag can change by changing the power system configuration. For including DG source in a radial distribution system, the modified model shown in Figure 3 is used.

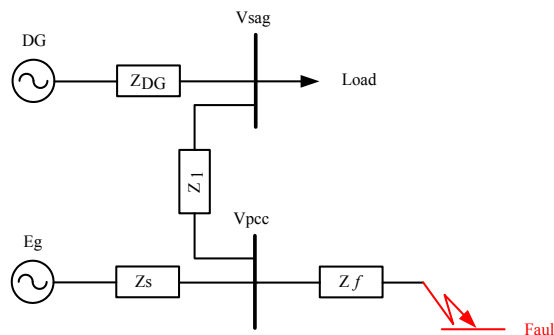

Figure 3: The modified model including DG in a radial distribution system [14]

The sag magnitude at the load can be calculated as follows:

$$V_{sag} = 1 - \left[\frac{Z_{DG}}{Z_{DG} + Z_1} (1 - V_{pcc}) \right] \quad (2)$$

Where

Z_{DG} : is the transient reactance of DG.

Z_1 : is the impedance between the PCC and the DG bus.

The increasing of DG resources capacity leads to decrease the line power flow, decrease voltage-drop and approaching V_{PCC} to 1 p.u. as a normal value. As a result, the voltage of sensitive load increases according to Eq. (2). Moreover, the DG resources location has effects on Z_1 and by increasing Z_1 sensitive load voltage can increase.

IV. Voltage sag and DG effect

DG with the possibility of controlling the voltage in the distribution network can reduce the voltage drop caused by starting the induction motor, changing the sudden load, etc., thus improving the quality of supply. Various DG capacities can supply different powers for the power system in the voltage sag cases. The voltage sag case have been because of the transfer the current for long line and depends on the amount of total load in the electric grid [15]. Then the DG is a good solution to decrease the current because of it near the load. In the next part explain the load flow with DG effect.

3. Mathematical modeling

I. Load flow analysis

Backward/Forward (BW/FW) sweep algorithm method is used for load flow analysis of radial distribution networks. In the backward sweep, Kirchhoff's current law (KCL) and Kirchhoff's voltage law (KVL) are used to calculate the bus voltage from the farthest bus. In forward sweep, downstream bus voltage is updated starting from source node. Line losses are calculated afterwards using the updated bus voltage. Using this method, load flow solution for a distribution network can be obtained without solving any set of simultaneous equations. To explain the method, Figure 4 shows a simplified distribution radial feeder [16].

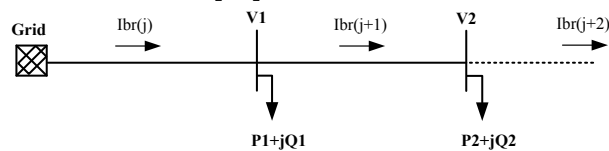

Figure 4: Balanced three-phase distribution feeder

Starting from far bus, the load current at this bus

$$I_b(i) = \left(\frac{S_b(i)}{V_b(i)} \right)^* \quad (3)$$

where

I_b : the load current of bus (i).

S_b : the apparent power of bus (i).

V_b : the voltage of bus (i).

Backward sweep

In this process, the branch current is calculated by adding all branch currents from end node to starting node.

$$I_{br}(j) = I_{br}(j+1) + I_b(i) \quad (4)$$

where

I_{br} : the branch current of branch (j).

Forward sweep

In this process, with the branch current obtained in Eq. (4), the bus voltage is

$$V(i+1)^{k+1} = V(i)^{k+1} - I_{br}(j)^{k+1} \times Z_{br}(j) \quad (5)$$

where

$V(i+1)$: the voltage of bus ($i+1$) in iteration (k).

$V(i)$: the voltage of bus (i) in iteration (k).

Z_{br} : branch impedance of branch (j).

After calculating bus voltages and branch currents using BW/FW sweep algorithm, the line losses are computed.

$$P_{loss}(j) = I_{br}^2(j) \times R_{br}(j) \quad (6)$$

$$Q_{loss}(j) = I_{br}^2(j) \times X_{br}(j) \quad (7)$$

II. Real Code Genetic Algorithm (RCGA)

Genetic algorithms are functional, strong optimization and study methods. GA were fabricated by Holland to imitative some of the operation of natural evolution and election. These algorithms are various from most of the classic optimization ways and these algorithms need styling space to be transformed into genetic space. A more visible difference between GAs and most of the classic optimization methods is that GA uses a population of points at once time, in contrast to the single point approach by classic optimization methods.

III. Differential Evolution (DE) Algorithm

In 1995, Storn and Price have suggested a new floating-point encoded evolutionary algorithm for global optimization and dubbed it DE algorithm due to an exceptional type of differential factor that called to create new offspring from the original chromosomes instead of the classic crossover or mutation [17].

DE is an improved type of GA, which provides rapid optimization. DE is a simple population-based search algorithm, which is very effective in handling restrictions of optimization problems. This algorithm can take care of optimality on uneven, non-continuous and multi-modal surfaces.

DE has some advantages over other approaches. It can find near optimum solutions regardless of primary parameters, its affinity is fast and requires few control parameters. In addition, its coding is simple and it can handle integer and discrete optimization [18].

The formulation of DE algorithm for optimal placement and sizing of DG mainly consists of objectives determination and handling of constraints [19].

DE algorithm has the following control parameters: scale factor (F), population size (NP), and crossover rate (CR). The algorithm is described below:

1) Initialization

The population initialization is an important procedure that assumes that there is no prior information about the optimal solution. The DE process begins with the nominee solutions initialization within the possible limits $[x_L, x_U]$. E.g. j -th component of the i -th decision vector is initialized as:

$$x_{i,j}^{(0)} = \sigma_{ij}(x_{U,j} - x_{L,j}) + x_{L,j} \quad (8)$$

where i from 1 to NP and j from 1 to d with d being the problem dimension. σ_{ij} is a uniformly distributed random number between 0 and 1. G is evolutionary algebra (maximum number of fitness evaluations). Superscript '0' denotes initialization.

2) Mutation

After initialization, there is mutation stage which is defined as the method of creating this donor vector that distinguishes between the different DE schemes. The initialized population is mutated using the following mutation strategy:

$$v_i^{(G+1)} = F(x_{r2}^{(G)} - x_{r3}^{(G)}) + x_{r1}^{(G)} \quad (9)$$

where v_i is the donor/mutant vector. x_{r1} , x_{r2} , and x_{r3} are the three vector parameters. These are selected randomly from the existing population and do not coincide with the current x_i . F is a positive control parameter to scale the difference of any two of the three vectors. The effect of 2nd and 3rd selected vectors in mutation process are controlled by F .

3) Crossover

There are two types of crossover schemes that can be used with DE techniques. These are exponential and binomial crossovers. In crossover stage, the donor/mutant vector v_i forms the trail vector $u_{i,j}$ by reciprocate the donor vector with the target vector $x_{i,j}$. To control the crossover probability, CR parameter is used. The binomial crossover for an element can be expressed as:

$$u_{i,j}^{(G+1)} = \begin{cases} v_{i,j}^{(G+1)} & \text{if } (CR \geq \mu_{ij}) \\ x_{i,j}^{(G+1)} & \text{otherwise} \end{cases} \quad (10)$$

where μ_{ij} is a uniformly distributed random number between 0 and 1.

4) Selection

In this stage, the DE algorithm uses selection operator to choose the optimal solution. DE decides that the target vector $x_{i,j(t)}$ has an objective function greater than or equal to the function of the trail vector $u_{i,j(t)}$.

$$x_i^{(G+1)} = \begin{cases} u_i^{(G+1)} & \text{if } f(x_i^{(G)}) \geq f(u_i^{(G+1)}) \\ x_i^{(G)} & \text{otherwise} \end{cases} \quad (11)$$

5) Termination Criteria:

The following criteria are used to terminate the iterative procedure:

1. The acceptable solution has been reached.
2. The number of iterations or maximum number of fitness evaluations has been finished.
3. When no more upgrading in the solution is reached.
4. Control parameter has getting close to a stable state.

This project used the 2nd criteria because of the maximum number of fitness evolution equal (20×10^3) . The flowchart of DE algorithm is shown in Figure 5.

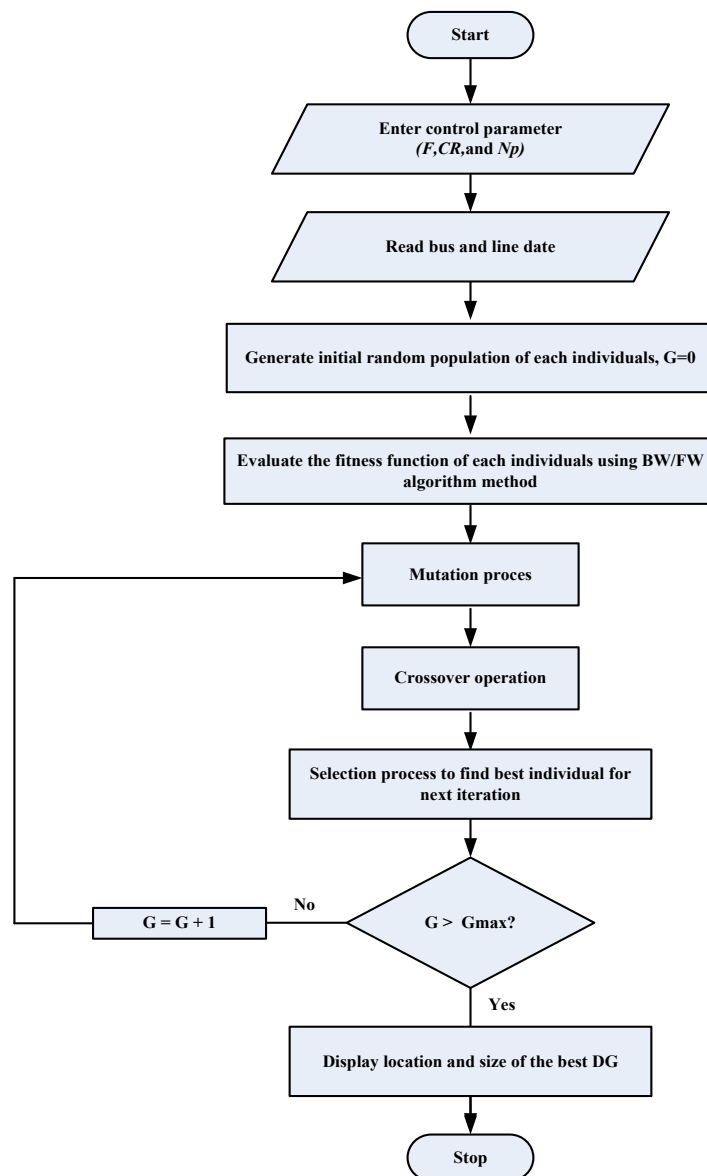

Figure 5: Flow chart of proposed DE algorithm

4. Simulation Results and Discussion

The proposed algorithm has been tested on IEEE 33-bus system and then applied to part of Baghdad distribution networks (Al-Masbh distribution network). Three cases are considered in each network.

Case 1: The base case load flow analysis.

Case 2: The optimal DG allocating in the network.

Case 3: The voltage sag analysis.

I. The IEEE 33-Bus System

Figure 6 shows the IEEE 33-bus system, the system detailed data is given in [20].

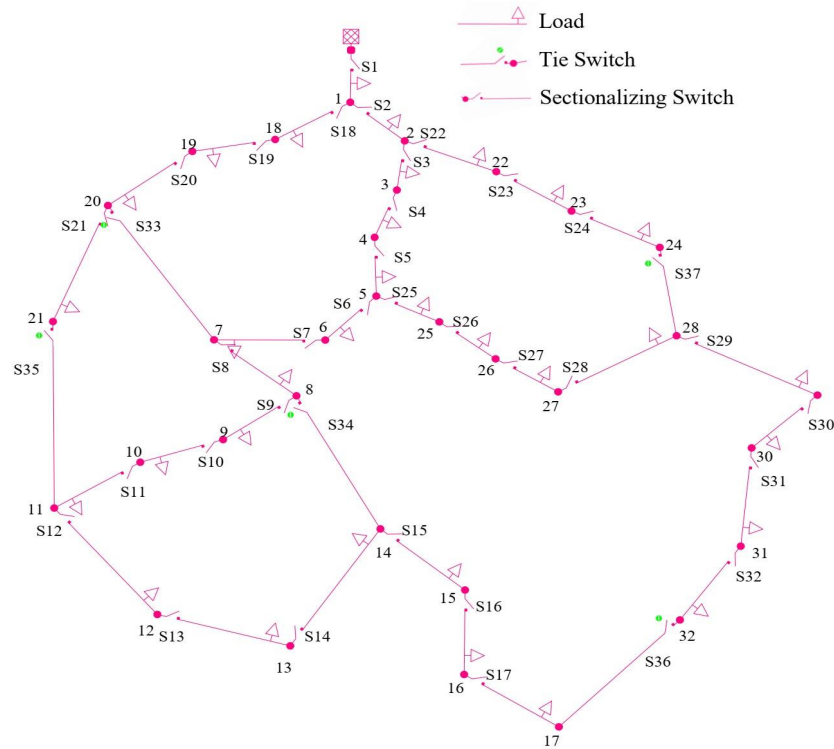

Figure 6: Single line diagram of IEEE 33-bus system without DG

Table II presents the results obtained without DG units and with DG units using proposed algorithm.

TABLE II: DE results of optimal locations and sizes of DGs for IEEE 33-bus system

Case	Size in kW (@ Bus No.)	Power losses (kW)	Min voltage in p.u. (@ bus No.)
Without DG	-	202.26	0.9132 (18)
With DG	733.9 (14)	72.61	0.968 (33)
	733.9 (25)		
	1032.65 (30)		

Figure 7 shows voltage profile before and after adding the DG.

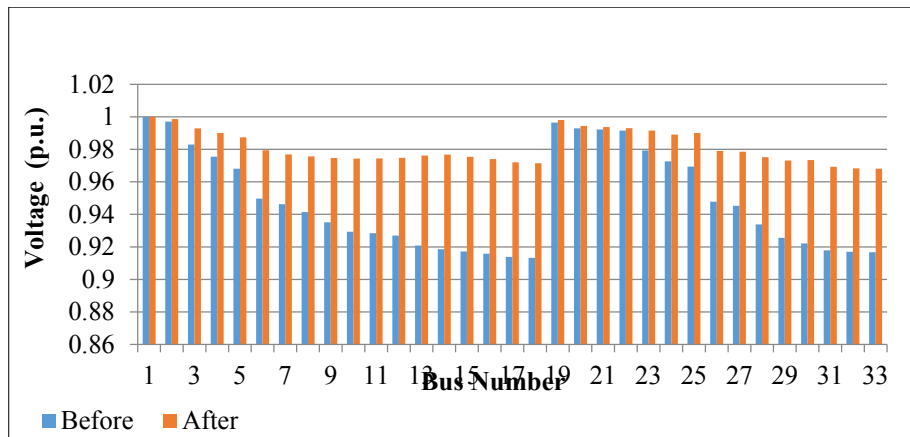

Figure 7: IEEE 33-bus voltage profile before and after DG placement

Figure 8 shows the optimal location of DG units in the IEEE 33-bus.

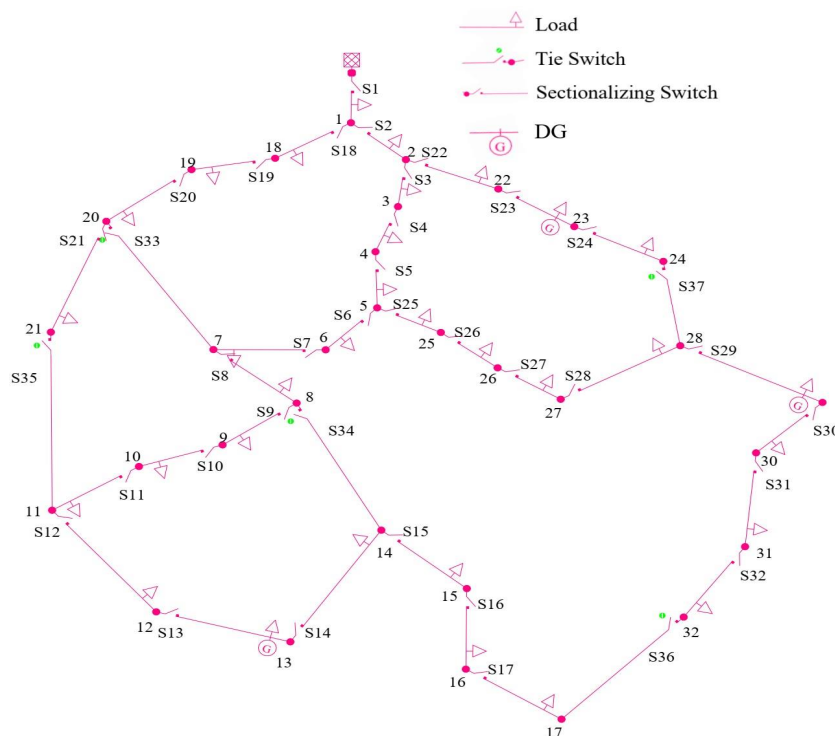

Figure 8: Single line diagram of IEEE 33-bus system with DG

To implement the voltage sag analysis on the IEEE 33-bus system using CYME software, a 3-phase fault is simulated on the IEEE 33-bus system. Before the application of the proposed method to mitigate voltage sag, it is assumed that all bus voltages are maintained within the limits of $\pm 5\%$ of their respective voltage levels for proper operation. In the simulation, the base case load flow is initially solved to determine the pre-fault voltage of each bus as the pre-sag value before fault isolation and DG placement. Then, a fault is simulated on section_8 and all the bus voltages during and after fault in the network is recorded. The final step of the simulation involves fault isolation where the network switches are manually changed to isolate the faulty bus and DG placement to mitigate the effect of voltage sags in the network.

After performing fault analysis in CYME software, this result in voltage sag and loss of power supply to sections (9 to 18). It can be noted that this feeder operates in an abnormal condition. Table III represents the percentage voltage level in each section.

TABLE III: The percentage voltage level in each section of IEEE 33-bus system with fault simulation at section_8

Voltage lower than (%)	Voltage larger than (%)	Number of sections
0.0	10.0	9, 10, 11, 12, 13, 14, 15, 16, 17
10.0	40.0	6, 7
40.0	50.0	25, 26, 27, 28, 29, 30, 31, 32
50.0	80.0	3, 4, 5
80.0	95.0	2, 22, 23, 24
95.0	100.0	1, 18, 19, 20, 21

Switch (S8) is opened to clear fault, and switch (S9) is opened to isolate the damage, Power supply can be restoration by closing tie switch (S36) and allowing transferring of (615 kW) via the tie line switch after fault isolation. It is very clear that the feeder still operates at abnormal condition with a lot of sections at under voltage state (below 0.95 p.u.), as shown in Figure 9.

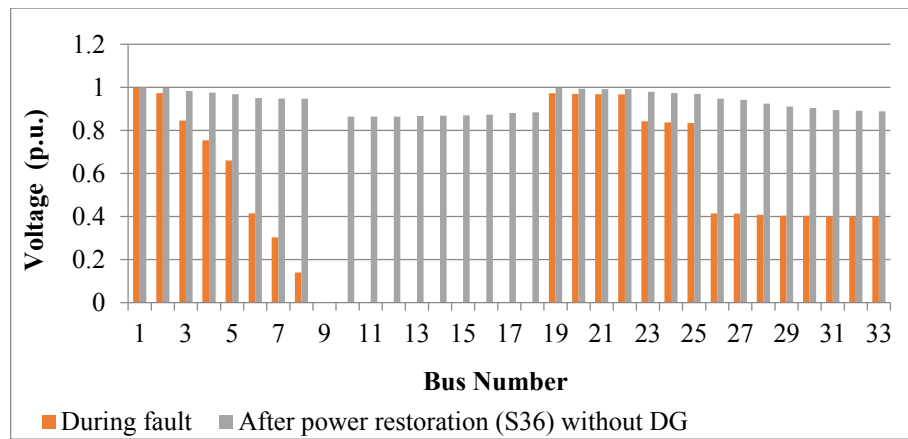

Figure 9: IEEE 33-bus voltage profile during fault and after power restoration through (S36)

After that, a DG with the same size and location of Figure 8 is introduced in the IEEE 33-bus system to get the maximum benefits of it, especially in the voltage profile improvement and loss reduction. Figure 10 shows voltage profile during fault and after power restoration with DG placement.

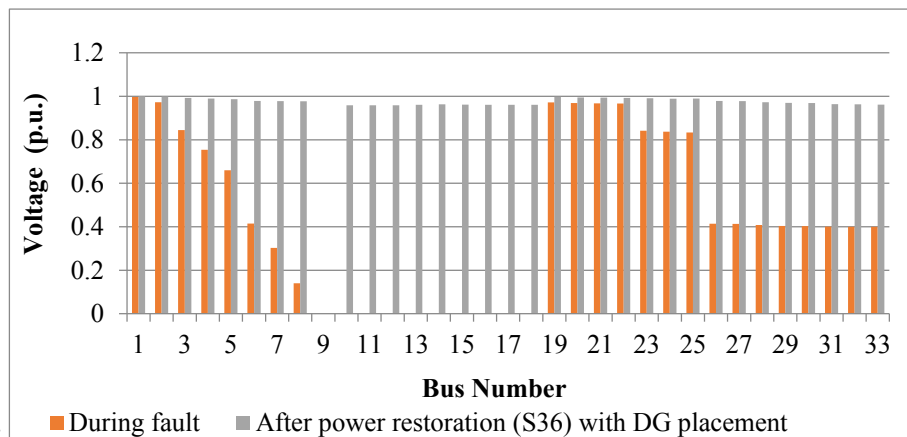

Figure 10: IEEE 33-bus voltage profile during fault and after power restoration through (S36) with DG placement

II. Al-Masbh Network

This network is a part of the distribution system in Baghdad city which is rated at (11 kV), base (100 MVA), and frequency of (50 Hz) with 2 feeders, 44 lines sections and 2 tie switches from them, 43 bus. The network is shown by the CYME software in Figure 11. The network data for feeder 2 given by Ministry of Electricity (MOE) are given in Table IV.

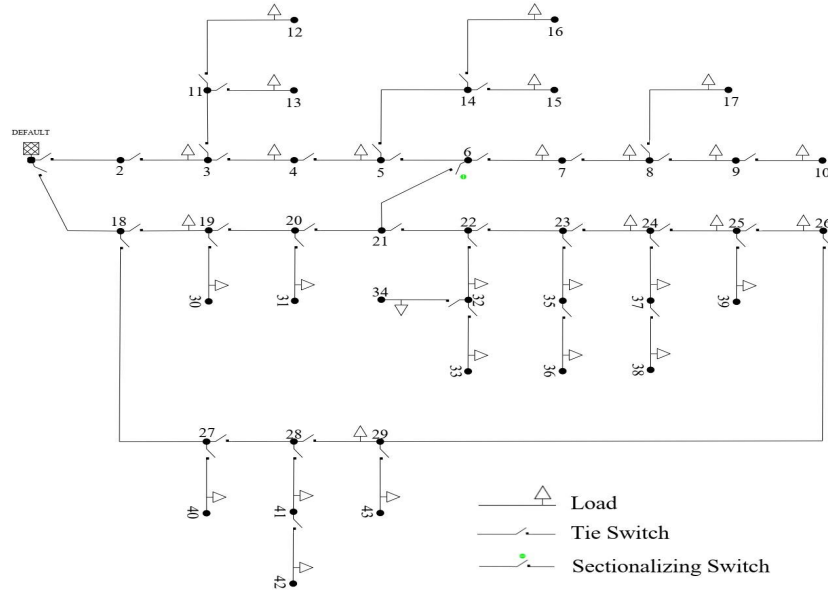

Figure 11: Single line diagram of Al-Masbh network without DG

TABLE IV: Line and load data for the AL-Masbh network, feeder-2 [MOE]

Section No.	From	To	R (ohm)	X (ohm)	PL (kW)	QL (kVAR)
17	S-N-1	18	0.0218	0.016	0	0
18	18	19	0.0583	0.0639	200	150
19	19	20	0.0359	0.0393	0	0
20	20	21	0.0229	0.0252	0	0
21	21	22	0.097	0.1064	0	0
22	22	23	0.033	0.0362	0	0
23	23	24	0.0085	0.0093	200	150
24	24	25	0.0197	0.0217	200	150
25	25	26	0.0437	0.0479	200	150
26	18	27	0.0167	0.0181	0	0
27	27	28	0.0224	0.0245	0	0
28	28	29	0.0054	0.0138	200	150
29	19	30	0.0195	0.0214	200	150
30	20	31	0.0202	0.0222	340	210.71
31	22	32	0.0102	0.0112	200	150
32	32	33	0.0076	0.0083	200	150
33	32	34	0.0034	0.0037	200	150
34	23	35	0.0169	0.0185	200	150
35	35	36	0.0216	0.0237	200	150
36	24	37	0.0309	0.0334	200	150
37	37	38	0.0298	0.0327	200	150
38	25	39	0.0332	0.0364	200	150
39	27	40	0.0465	0.051	200	150
40	28	41	0.0538	0.0138	200	150
41	41	42	0.0193	0.0212	200	150
42	29	43	0.0282	0.0309	200	150
*43	6	21	0.0122	0.0134	---	---
*44	26	29	0.0103	0.0113	---	---

* Tie switch

The increasing demand in the Iraqi distribution network and load as a result of natural population increase with the age of the network, which requires the development of distributed systems. These issues cause further voltage drop, increased losses, as a result reduction of the bus voltage stability and load unbalance. Therefore, the usage of DG has been increased.

The proposed DE algorithm, which was used for test IEEE 33-bus system is developed to include the optimal size and locations of DG units in the Al-Masbkh network. Table V presents the results of optimal size and locations of DG units and the power losses for the Al-Masbkh network.

TABLE V: DE results of optimal locations and sizes of DGs in Al-Masbkh network

Case	Size in kW (@ Bus No.)	Power losses (kW)	Min voltage in p.u. (@ bus No.)
Without	-	67.27	0.981 (43)
With	2000 (8)	28.61	0.991 (43)
	800 (25)		
	800 (37)		

Figure 12 shows voltage profile before and after adding the DG.

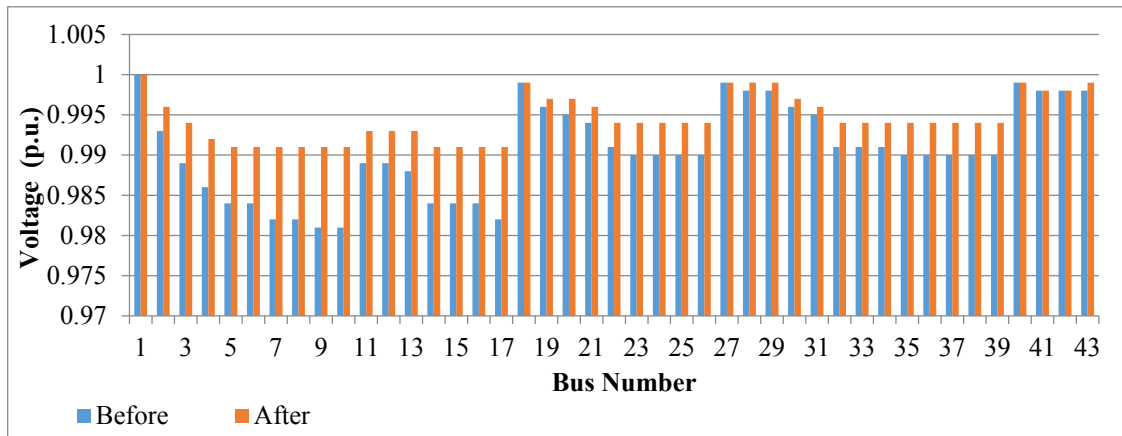

Figure 12: Al-Masbkh network voltage profile before and after DG placement

Figure 13 shows the optimal location of DG units in Al-Masbkh network.

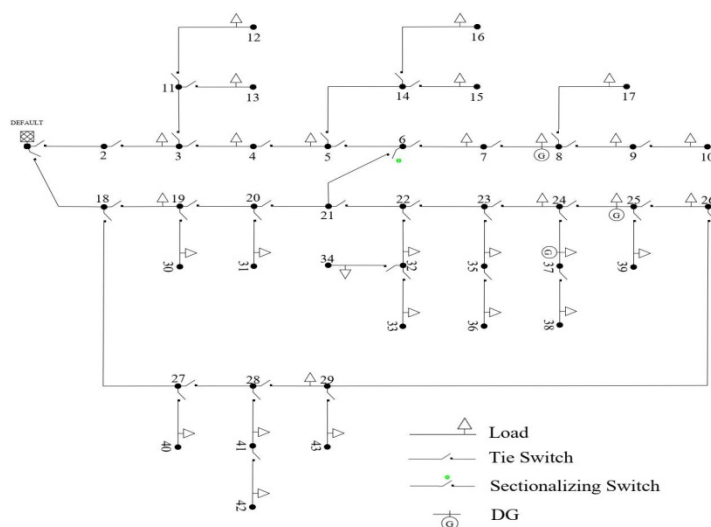

Figure 13: Single line diagram of Al-Masbkh network with DG

To implement the voltage sag analysis on the Al-Masbkh network using CYME software, A 3-phase fault is simulated on section_22, this result in loss of power supply to sections (23 to 25) and

sections (23-35 to 38), the total load for the unserved consumers is 2200 kW. Due to high fault current in the Al-Masbh network, the voltage sag is evident in the network buses.

Switch (S22) is opened to clear fault, the only way to restoration the power supply to sections (23 to 25) and sections (23-35 to 38) is by closing tie switch (S44) and allowing transferring of (2200 kW) via the tie line switch after fault isolation. By analysis of the results, the CYME calculated by divided the current of feeder-2 (258 Amperes) on the current value of feeder capacity (238 Amperes) to find a current line loading of section_17 equal (108.4 %) still operates in an abnormal condition. hows voltage profile during fault and after power restoration without DG placement.

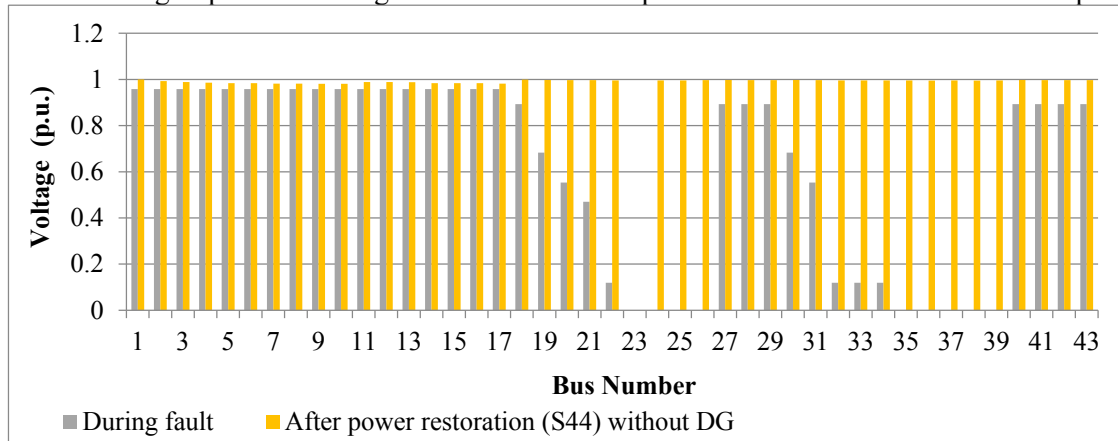

Figure 14: Al-Masbh network voltage profile during fault and after power restoration through (S44)

To achieving further service restoration in the distribution system requires the addition of new DG units. With DG placement, the CYME calculated by divided the current of feeder-2 (196.6 Amperes) on the current value of feeder capacity (238 Amperes) to find a current line loading of section_17 is reduced to (82.6.2%). Figure 15 shows voltage profile during fault and after power restoration with DG placement.

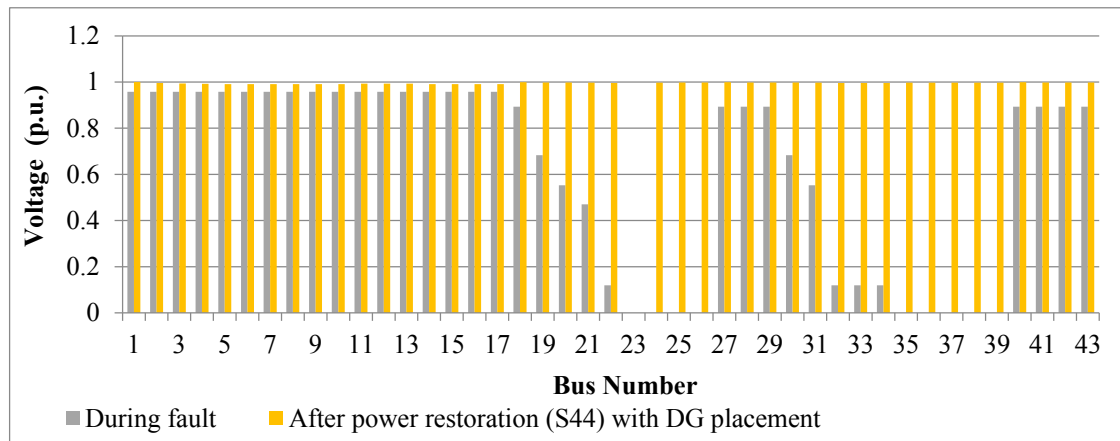

Figure 15: Al-Masbh network voltage profile during fault and after power restoration through (S44) with DG placement

5. Comparison

Based on DE algorithm, a program was written in MATLAB to find the optimal sizes and locations of DG units. It is assumed that the maximum numbers of DG that can be added in the system is 3. The program was applied to the test system and the results are compared with the results of [9] which used RCGA as introduced. The results in Table II came from employed DE algorithm on IEEE 33-bus shown the power losses with DG equal 72.61 kW, while the paper [9] used RCGA to determine the optimal located and sizes DG the results are in Table VI shown the power losses with DG equal 79.2515 kW. From comparison the results of two algorithms noted the results of DE algorithm better than results of RCGA.

TABLE VI: Results of RCGA to find Optimal locations and sizes of DGs for IEEE 33-bus system [9]

Case	Size in kW (@ Bus No.)	Power losses (kW)	Min voltage in p.u. (@ bus No.)
With DG	1740 (6)	79.2515	0.9349 (18)
	570 (15)		
	762.6 (25)		

6. Conclusion

The simulation results of DE by using MATLAB and CYME shows the validity and effectiveness of the proposed method to voltage sag mitigation. Comparison results of DEA with RCGA both applied on IEEE 33-buss the DEA better than RCGA to determine the power losses in the grid that made us to depend on DEA to employ it. The implementation of the power restoration with DG after fault on IEEE 33-bus system and Al-Masbh network show the capability of the maintaining the current flows and voltage levels in the network within their acceptable limits. The results show that, the optimal locations of DG are near the buses that carry more loads. The DG units in IEEE 33-bus system and Al-Masbh network improve the voltage magnitude, because the line power flow decreases, and the voltage magnitude increases in several buses especially nearest the DG buses.

References

- [1] V. P. Mali, R. L. Chakrasali, K. S. Aprameya, A Technical Investigation of Voltage Sag, Am. J. Eng. Res., 4 (2015) 60-68.
- [2] M. H. J. Bollen, Understanding Power Quality problems Voltage Sags and Interruptions, 1st Edition. Wiley-IEEE Press. 2000.
- [3] R. Al-Abri, Voltage Stability Analysis with High Distributed Generation DG Penetration, Ph. D. Thesis, University of Waterloo, Ontario, Canada, 2012.
- [4] I. I. Ali, O. Y. Saeed, Optimal Reconfiguration and Distributed Generation placement in Baghdad Distribution Sector, Eng. Technol. J., 35(2018)333-343. <http://dx.doi.org/10.30684/etj.36.3A.13>
- [5] E. Nasrolahpour, H. Ghasemi, H. Monsef, E. Khoub, DG placement considering voltage sag and losses, Int. Conf. Electr. Eng., IEEE. (2012) 18-25. <https://doi:10.1109/EEEIC.2012.6221505>
- [6] G. V. K. Murthy, S. Sivanagaraju, S. Satyanarayana, B. H. Rao, Optimal Placement of DG in Distribution System to Mitigate Power Quality Disturbances, Int. J. Electr. Comput. Eng., 07 (2013) 266-271.
- [7] S. Patel, A. K. Sharma, P. G. Scholer, Optimal DG Allocation and Sizing for Mitigating Voltage Sag in Distribution Systems Using Particle Swarm Optimization, IOSR J. Eng., 1 (2013) 16-23.
- [8] S. A. M. Moussa, A. Abdelwahed, Optimum Allocation of Distributed Generation units in Distribution Power Grids with Line Losses and Voltage Sag Considerations, IEEE, Annual Connecticut, Conf. ind. Elect. Technol. Autom., (2016) 14-15. <http://dx.doi.org/10.1109/CT-IETA.2016.7868260>
- [9] M. P. Lalitha, A Two Stage Methodology for Siting and Sizing of DG for Minimum Loss in Radial Distribution System using RCGA, Int. J. Comput. Appl. Technol., 25(2011)10-16. <http://dx.doi.org/10.5120/3005-4048>
- [10] A. F. Zobia, R. Bansal, M. Manana, Power Quality Monitoring, Analysis and Enhancement, In. Tech, Croatia. September., (2011) 380. <http://dx.doi.org/10.5772/1425>
- [11] T. I. ElShennawy, Voltage Sag Effects on the Process Continuity of a Refinery with Induction Motors Loads, Am. J. Appl. Sci., 6 (2009) 1626-1632. <http://dx.doi.org/10.3844/ajassp.2009.1626.1632>
- [12] Guide for Voltage Sag Indices, IEEE. Power. Energy. Soc. Std., 1564 (2014). <http://dx.doi.org/10.1109/IEEESTD.2014.6842577>
- [13] G. Karady, S. Saksena, N. Senroy, Effects of Voltage Sags on Loads in a Distribution System, Power. Sys. Eng. Res. Center., 2005.

-
- [14] S. Biswas, S. K. Goswami, A. Chatterjee, Optimum distributed generation placement with voltage sag effect minimization, *Energy. Convers. Manag.*, 53 (2012) 163-174. <http://dx.doi.org/10.1016/j.enconman.2011.08.020>
- [15] A. Ghosh, G. Ledwich, *Power Quality Enhancement Using Custom Power Devices*, Springer. ser., 2002.
- [16] G. Peddanna, Y. S. R. Kishore, Power Loss Allocation of Balanced Radial Distribution Systems, *Int. J. Sci. Res.*, 48 (2015) 360-366.
- [17] R. Storn, K. Price, Differential evolution – a simple and efficient adaptive scheme for global optimization over continuous spaces, *J. Glob. Optim.*, 23 (1995).
- [18] S. K. Morya , H. Singh , Reactive Power Optimization Using Differential Evolution Algorithm, *Int. J. Eng. Trends . Technol.*, 4 (2013) 4253-4258.
- [19] Y. Tan, Y. Shi, B. Niu , *Advances in Swarm Intelligence*, Chiang Mai Thailand, Proc. Int. Conf., CSI (2019) . <https://doi.org/10.1007/978-3-030-26369-0>
- [20] M. P. Hajiabbas, B. M. Ivatloo, *Optimization of Power System Problems: Methods, Algorithms and MATLAB Codes*, 1st Edition, Springer, (2020) .