



Programing and Procedure Design of Stand-alone PV System for Clean Energy Home Supply in Baghdad

Sarah A. Al-shammari^{a*}, AbdulHassan A. Karamallah^b, Sattar Aljabair^c

^a Mechanical Engineering Department University of Technology, Baghdad, Iraq,
21552@student.uotechnology.edu.iq

^b Mechanical Engineering Department University of Technology, Baghdad, Iraq
20005@uotechnology.edu.iq

^c Mechanical Engineering Department University of Technology, Baghdad, Iraq
20010@uotechnology.edu.iq

*Corresponding author.

Submitted: 15/01/2021

Accepted: 13/04/2021

Published: 25/07/2021

KEY WORDS

Stand-alone PV,
Renewable energy,
Photovoltaic, Clean
Energy, Home supply,
Baghdad

ABSTRACT

Global demand for energy production is in an increasing trend. However, a gap between energy production and energy demand still represents an industrial challenge. Iraq, like too many developing countries, is an example of such problematic. To tackle these issues, renewable energy could be a valid solution. Renewable energy becomes necessary especially the unique location of the received solar energy and long daylight. Many pieces of research deal with maximum benefit from this condition. This paper discusses the design stand-alone PV system for one home in Baghdad and sizing all components in that system start with energy demand, inverter power, PV, battery bank, and connections with each other by design a simple calculation program. Computational modeling was performed to evaluate different designs. Cost efficiency of system performance based on the domestic market prices was estimated and compared with electrical provide from conventional electrical plants (grid and local generator).

How to cite this article: S. A. Al-shammari, A. A., Karamallah, and S. Aljabair, "Programing and Procedure Design of Stand-alone PV System for Clean Energy Home Supply in Baghdad," Engineering and Technology Journal, Vol. 39, No. 07, pp. 1164-1173, 2021.

DOI: <https://doi.org/10.30684/etj.v39i7.1976>

This is an open access article under the CC BY 4.0 license (<http://creativecommons.org/licenses/by/4.0>).

1. INTRODUCTION

Oil is the main power source for electricity In Iraq. However, due to the rapid depletion of fuel, high gas prices, and global warming in addition to many hours of outages, and environmental pollution due to the burning of fuel, renewable energy gives a reasonable solution to these problems. This paper aims to focus on the maximum uses of a solar PV system to supply the home and reduce its environmental impact carbon dioxide emission conditions. Solar energy has not been utilized

adequately in Iraq. The worldwide solar radiation ranges between 2000 kW/m² to 2500 kW/m² annual daily average[1]. The quantity of sunlight received by each surface on earth relies on various factors including; geographical site, season, domestic landscape, time of the day, and local climate.[2,3].

By 2040, power generation dependent on RES is expected to be 50%, in the European Union, around 30% in China and Japan, and higher than 25% in the United States and India; While the use of coal will not exceed 15% of the electricity feed outside Asia. Power plants aggravate the effect of global warming and pollution, as a consequence, to use traditional method to generate electricity [4].

Stand-alone PV systems work reliably and are the better option for numerous remote applications around the world. Obtaining dependable long-term performance from a PV system requires: regular sizing calculations, knowing about the hardware availability and performance, employ of good engineering practices when installing equipment, and developing and following a perfect operation and maintenance plan[5]. Many studies deal with the design and optimization of PV systems in many countries around the world with and without software to get the best performance with low cost and long-life cycle. Some program suits for the system type and other not so it is summarized in review to help researchers as shown in Table I [6]. Design and optimization with sun tracking to study the effect of temperature with HOMER software to study the net presented cost NPC and cost of energy COE in Kirkuk city, Iraq. Both NPC and COE are inversely proportioning with temperature and direct proportion with operating cell temperature [7]. While in Bangladesh study the optimization of PV system for an electric vehicle at the university campus in Dhaka. They found the energy-saving is approximately 21% of total production to charge electric vehicle station and reduced the emission of greenhouse gasses[8]. Another application for a standalone PV system is Pumped Storage with the developed model, a technically and economically feasible power supply solution can be achieved easily to the island by sizing and optimization with the GA method to achieve lower COE values [9]. The financial analysis and economic analyses of PV system studied with different system design such as a daily light load of the Florsheim Hall at the University of Missouri-Kansas City, USA, and household in Pakistan [10,11]. In this paper design, a simple calculation program for stand-alone PV system sizing and use for small application load demand.

TABLE I: Comparison of commercial PV software tools for simulation capability [6].

	SAPV	PV/Win	PV/Diesel	GC
RETScreen	x	x	x	x
PV F-Chart		x	x	
Solar Design Tool	x	x	x	
INSEL	x	x	x	x
TRNSYS	x	x	x	x
NREL SAM	x	x	x	x
PVSYST 4.33		x	x	
SolarPro	x	x	x	x
PV DesignPro-G	x	x	x	
HOMER				
PV.MY				

2. SITE METEOROLOGICAL DATA

Iraq has a good geographical location; it extends between the two latitudes north 37 22 and 29 5. this site unique in terms of incidence angle of radiation and the number of daylight hours, which lengthen in summer days (14 hours) and recede in winter days to (around 10 hours). The Mediterranean Sea is the greatest effective body of water near Iraq, where climatic weather depressions happen over half a year through winter, causing rainfall and changes in temperature see Figure 1,[1].

The site meteorological data is needed to predict the performance of the PV system were obtained from the Iraqi meteorological organization and seismology, the ministry of transportation,

and the Renewable Energy Department of the Iraqi Ministry of Science and Technology [12]. Iraq is lying in a region with 2000 kWh/m² to 2500 kWh/m² annual average daily energy from universal solar irradiation. The global solar division is set for three years as shown in Figure 2 [13].

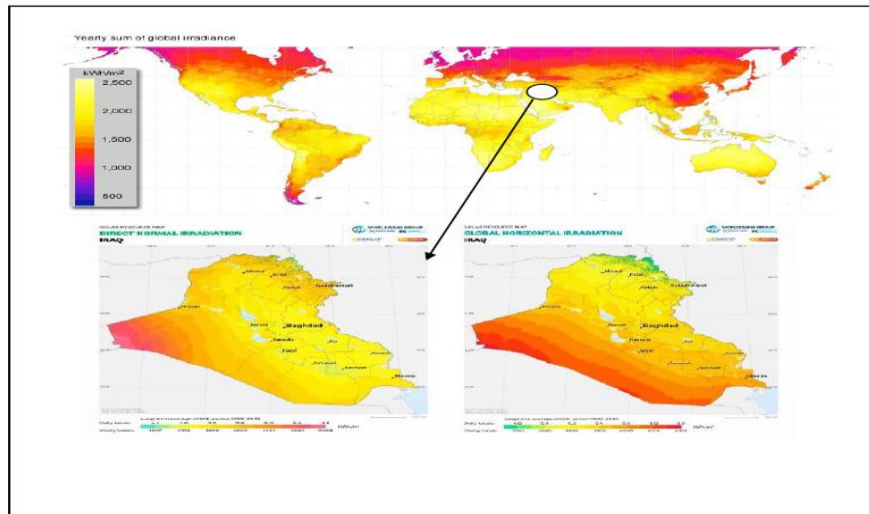

Figure 1: Iraq direct and global solar irradiation.[13]

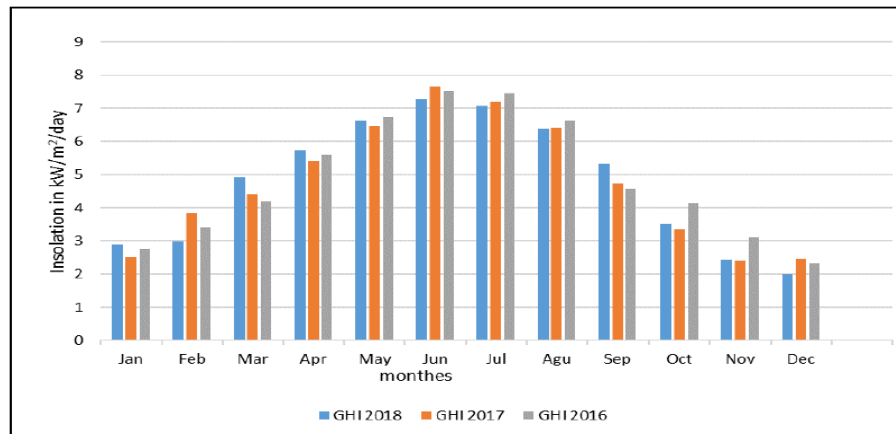

Figure 2: Incident global irradiation for Baghdad [12]

In a country like Iraq, finding novel resources of energy is not severe for the reason of how wealthy the country is in oil. However, Iraq does suffer from a high lack of electric power because of a growing demand Figure 3. At present-day, Iraq needs additional power, due to its increasing population and demands. The population of Iraq increased from 14 million in 1980 to 32 million in 2010, and it is predicted to rise to approximately 64 million in 2050. Thus, an increased amount of power is required to support economic development and to overcome daily power shortfalls. The Ministry of Energy reported that the highest requirement in 2008 was 12,000 MW of power, but barely 6000 MW was provided. These deficits will probably increase to 21,000 MW by 2020. The reason for the failure in electrical power stations failure to respond with the requested power is the bounded production capabilities like too many other countries, for that the interest in RES such as solar energy has increased in Iraq[1]. In the future, Iraq is expected to have the best fortune as a country rich in renewable energy resources. The key to designing a photovoltaic power system is associated with the performance of the photovoltaic model. Technologies, production processes, and operating conditions are important factors to design a PV system. PV performance under operation conditions is different than its performance under manufacturer specifications. Manufacturers test the performance under the standard test conditions (STC) defined at 100 Watt/m² solar irradiance and 25°C PV cell temperature [14].

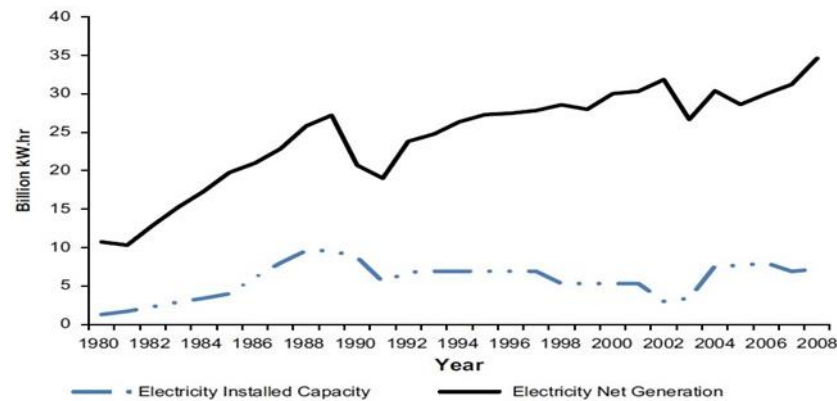

Figure 3: Projection of peak demand in Iraq until 2008[1]

3. METHODOLOGY

The first assignment in this work is the determination of load. Estimation of system load is a major factor in sizing and design a stand-alone PV system in addition to eliminate the cost analyses. The electrical loads available at the inhabitant were profiled with their particular control evaluations and average operation hours during the day noted to get the power request in watt-hour per day. The result of the analysis was used to determine the proposed system and selected component that shows in Figure 4 and its size.

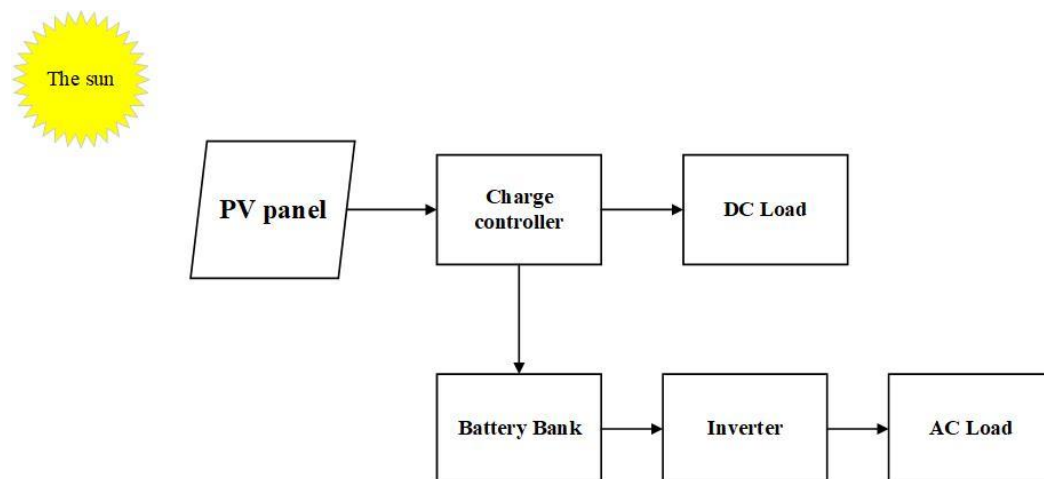

Figure 4: Block diagram of stand-alone photovoltaic system

I. Resident Electrical Demand

The household is a medium-size home not requiring a high quantity of electrical energy. Table II shows the various electrical appliances and their load chat. The design method is achieved by hand calculation, computer programing, and combination between them.

For designing, installing, and operating stand-alone PV systems it is recommended [5]

- 1) Keep it simple
- 2) Comprehend system availability
- 3) Be thorough, but realistic, when estimating the load
- 4) Cross-check weather sources
- 5) Know what available hardware and what it cost
- 6) know the installation location before designing the system
- 7) Install the system carefully
- 8) Safety first and last
- 9) Plan periodic maintenance

- 10) Estimate the life-cycle cost (LCC) to compare PV systems to alternate.

II. Sizing of the solar system

Sizing of photovoltaic it is not complicated but we must complete it before start purchase and installation to work perfectly and avoid use the over cost or losses. The sizing of PV system includes the following points,

A. Sizing and load selection

The first step is to estimate the daily consumption of the electrical device. This step is summarized by filling in the table for the simple arithmetic program that has been done. It was including all the devices to be operated and determining the capacity of each device and eliminate the number of hours of operation of each device and determining the capacity of the take-off that needs such as the refrigerator and pumps.

$$\text{Load Power (Wh)} = \text{power device} \times \text{no.} \times \text{Daily average usage (hr)} \quad (1)$$

B. Sizing and the batteries selection

The solar system independent of the grid mainly relies on batteries to store the energy produced from the solar panels during the period of sunshine for use during the night or as a stock when charging is not possible due to the clouds in the winter season.

The storage capacity can be calculated using the equation,[15]

$$C_{Batt.} = \frac{DAL \times N_a}{DOD \times V_{sys.} \times \eta_{bat.}} \quad (2)$$

Due to the losses occurring during the conversion from DC to AC by inverter efficiency, the difference is calculated by dividing the capacitance value by the inverter efficiency. For calculating the number of batters required the capacity of the system required is divided by the nominal battery capacity. The number of units connecting in series is found by dividing system voltage to the battery voltage and the number of parallel unite is found by dividing the capacity required by the number of batteries in series.

C. Sizing and PV model selection

To find the ability of the solar panels needed to supply for required energy, we will determine the daily solar radiation value is determined for the specified location and choose the lowest radiation value for design.

The output power of PV array (PPv array) is given by Eq. (3),[16]

$$P_{pv \text{ array}} = \frac{EId}{\eta_{B.o} \times K_{Loss} \times I_{sol.}} \times SIP_{SE} \quad (3)$$

Where:

$$\eta_{B.O} = \eta_{invertor \ losses} \times \eta_{wiring \ losses} \quad (4)$$

is the efficiency of the balance of the system

PSE is the peak solar intensity at the earth's surface (1000 W/m²), and K_{Loss} is a factor determined by the different losses such as module temperature losses, circuit losses, dust, etc. Typical values for $\eta_{Inverter}$ losses, η_{Wiring} losses, and K_{Loss} are 15%, 10%, and 90% respectively[17].

Determining the number of models in series (Ns) is obtained by

$$N_s = \frac{V_{sys}}{V_{model}} \quad (5)$$

Where V_{sys} depended on the characteristics of the inverter [5].

the number of strings in parallel (N_p), is obtained by dividing the amount of the total array output capacity by the number of modules in series multiplied by the power of the nominal PV panel as shown in Eq (6)[15].

$$N_p = \frac{P_{pv\ array}}{N_s \times P_{Module}} \quad (6)$$

D. Sizing and inverter

In the stand-alone system, the inverter must have a power 20- 25% more than related power for the system[15,18]. Most modern inverters have a charging controller, based on what is currently available in the local market. The inverter power rating is given by Eq. (7) [15]

$$P_{invt} = (P_{rs} + P_{isc}) \times 1.25 \quad (7)$$

Where,

P_{rs} is the power of appliances running simultaneously and P_{isc} power of large surge current.

E. Charge Controller Sizing

The charge controller regulates the inflow of electricity from the solar modules (PV) to the storage system (battery). When the battery bank is down level, the charge controller feeds all of the electricity from the array to the batteries. When the batteries reach a state of full charge, the charge controller stops or redirects the feeding of electricity to prevent overcharging. The rated maximum current is given by the expression[15].

$$I_{max} = N_{mp} I_{sc} F_{esafety} \quad (8)$$

Where $F_{esafety}$ is safety factor =1.25

F. Wiring Sizing

Wiring sizing is the connection wires that carry electricity from panels to regulators, from the regulator to batteries, from batteries to inverter, and from the inverter to loads. The specific physical property of choosing an ideal conducting wire is known as electrical resistance, which is the resistance of a wire of a certain thickness and a specified length for the electric current to pass through it resulting from the shedding of an electrical potential difference between its terminals. The increase in the thickness of the wire reduces the resistance of the wire to the electric current, which weakens by turning it into a thermal loss that causes the wire to overheat, and while the extra length causes a loss in the electric potential difference between the two ends of this wire, in all cases it is required that the loss is not less than 3% of the value of the required voltage difference[5]. The cross-sectional area of the wire is given by [15].

$$S = \frac{L \times I}{\gamma \times V_d} \quad (9)$$

Where L is the length of wire, γ is the conductivity of copper = 58 m/ Ω .mm² and V_d is 2% of the maximum allowed voltage drop for the 2 series array PV.

4. THE DEVELOPED PROGRAM

The steps of sizing a stand-alone PV power system, qualified above, being arranged as a software package. The package is developed by Microsoft access basics database used to create a simple program for design stand-alone PV system with different load and application. A program was used to create a database and for various loads and component specifications available in the market with the ability to change the design and add load easily and simply. This program needs input data of selected components with work conditions as shown in Figure 5 [19].

5. PROCEDURE OF CALCULATION

Load estimation is done by choosing an application of a house model to calculate the electrical loads required to be provided by using a standalone PV system isolated from the grid (off-grid) as shown in Table II.

TABLE II: Electrical Load Demand for Residence

Application	Standard load	Quantity	Daily average usage (hr)	Total Wh/day
Refrigerator	100	1	24	2400
Television	100	1	8	800
Fan	75	2	24	3600
Light	30	6	10	1800
Sat Decoder	130	1	8	1040
Laptop	65	1	4	260
Washing machine	1000	1	1	1000
Σ	Prs=1500 W		DAL	10900Wh/day

The screenshot shows a software interface titled 'Total IP'. At the top, there are two input fields: 'Power Sum.' with the value '1500' and 'E id' with the value '10.9'. Below these is a table with the following columns: 'load', 'qt', 'power', 'hours', and 'lp'. The table contains the following data:

load	qt	power	hours	lp
Refrigerator	1	100	24	2400
Tv	1	100	8	800
Fan	2	75	24	3600
light	6	30	10	1800
Sat Decoder	1	130	8	1040
Laptop	1	65	4	260
washing Machine	1	1000	1	1000
	0	0		

At the bottom of the interface, there is a red button labeled 'Calculate'.

Figure 5: Load sizing view

6. RUNNING A COMPUTER PROGRAM AND RESULTS

Run the program is as easy as plug the calculate icon in Figure 6 to transfer of to the main view of the program. The main view divided into five boxes deals with the sizing of each part as described in previous equations Eqs. (1-9). The program provides a feature to show a definition of each variable in the input list to facilitate understanding of the program and how to working on it easily as shown in Figure 7.

As Figure 8 shows, the results, of the layout, contain the rating and number of the (PV, modules, batteries, charge controller, inverter, and the cross-section area of wire connection). The program is examined for many cases and validated with published paper result Figure 9 [15]; the case study presented has a result completely in agreement with the analytical method, thus validating the accuracy and discipline of the tool proposed in this paper. It's recommended to improve the program to be included the declination and tilt angle effect.

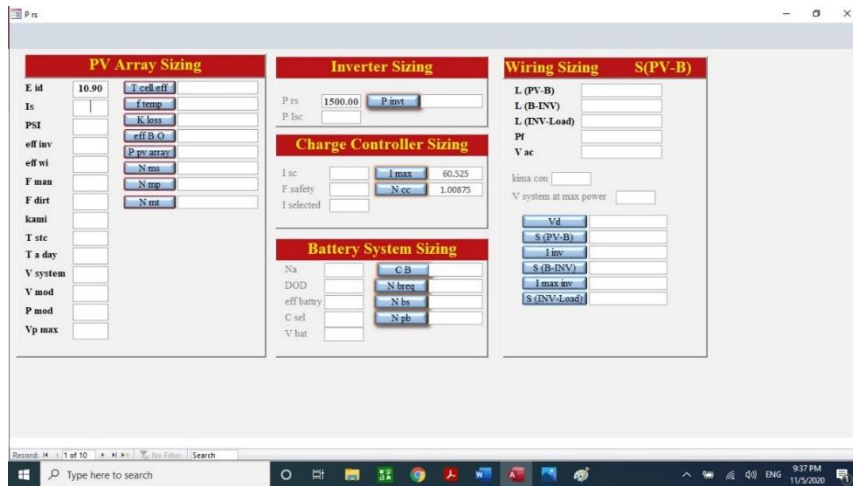

Figure 6: The main program view

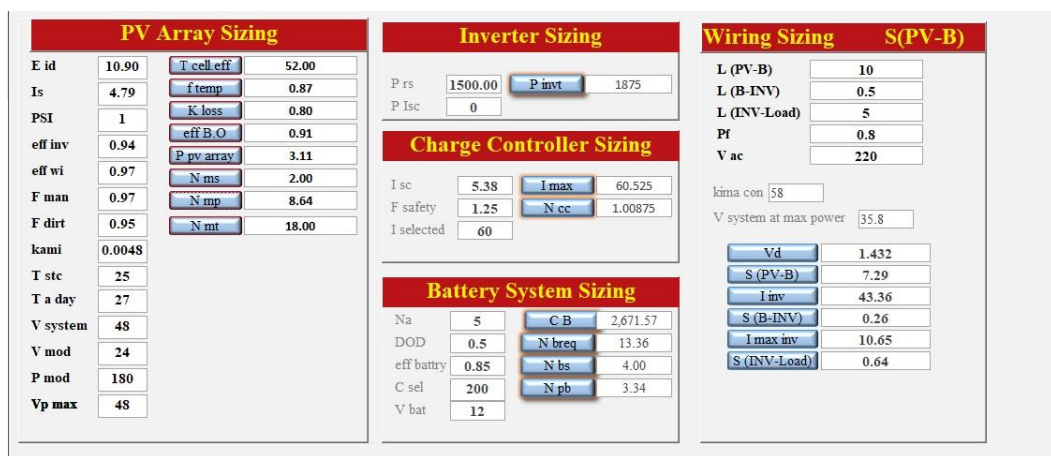

Figure 7: The final result of the program

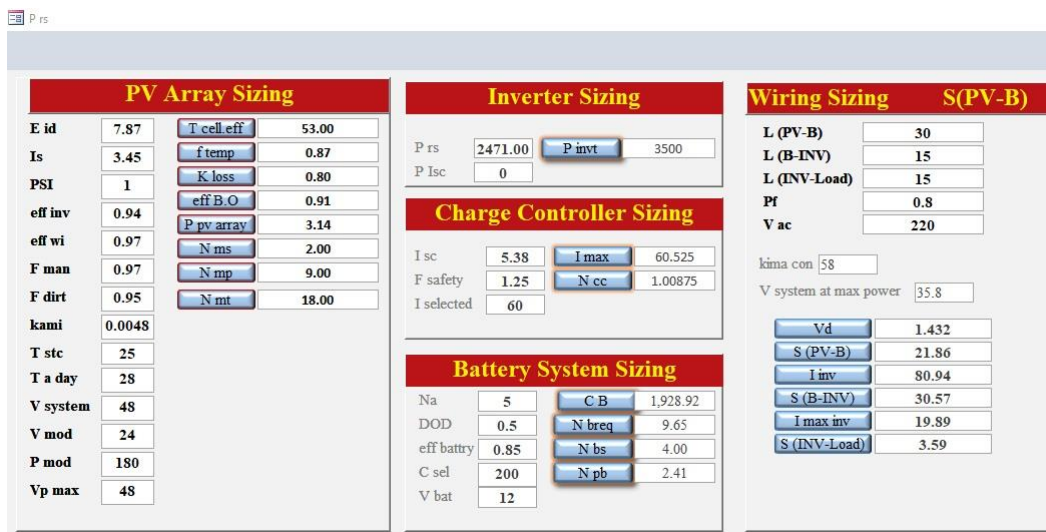

Figure 8: Validation results [18]

7. CONCLUSIONS

The conclusions drawn from this work can be summarized as:

- 1) Iraq has a geographical site with a sun-rich zone with more than 2000 kwh/m² from yearly solar irradiance.
- 2) There is great interest in how to employ the use of solar energy systems.
- 3) Many websites and program packages proposed a procedure and method to plan stand-alone photovoltaic frameworks.
- 4) Design a simple calculation program for stand-alone PV system sizing and use it for specific load demand.
- 5) The presented work has a special advantage, anyone who has simple engineering or technical background of the solar system by input the technical data which helps to prevalence the use of the solar cell energy can be run this program. that leads to critical financial, natural, social benefits.

Symbols and Abbreviations

PV	Photovoltaic	DOD	Depth of discharge
GA	Genetic algorithm	E_{Id}	Average daily load energy in KWh/day
NPC	Net presented cost	V_{sys}	System Voltage
COE	Cost of energy	$\eta_{bat.}$	Battery efficiency
SAPS	Stand-alone PV system	P_{rs}	power of appliances running simultaneously(w)
GC	Grid connection	DAL	Daily average usage(hr)
LCC	life-cycle cost	N_a	Number of days of autonomy
STC	Standard test conditions	C_{Batt}	Required minimum battery capacity
RES	Renewable energy sources	I_{sol}	the average solar radiation incident over Baghdad in kWh/m ² /day for the year 2009

References

- [1] H. H. and S. T. M. M. Al-kayiem, "Potential of renewable energy resources with an emphasis on solar power in Iraq : an outlook," Resour. Viewp., vol. 8, no. 42, 2019.
- [2] L. C. Chea, "Performance evaluation of new two axes tracking pv-thermal concentrator," J. Civ. Eng. Archit., vol. 7, no. 12, pp. 1485–1493, 2013.
- [3] D. D. Nguyen, B. Lehman, S. and Kamarthi, and Ph.D., "Performance evaluation of solar photovoltaic arrays including shadow effects using neural network," *IEEE*, pp. 3357–3362, 2009.
- [4] L. E. Singer and D. Peterson, International Energy Outlook 2016, vol. 0484, no. May. 2016.
- [5] U. S. Government, "stand -alone photovoltaic system: A HandBook of recommended design practices," Print. United States Am. Available from Natl. Tech. Inf. Serv. U.S. Dep. Commer. 5285 Port R. Road Springfield, VA 22161, 1995.
- [6] T. Khatib, A. Mohamed, and K. Sopian, "A Software tool for Optimal Sizing of PV Systems in Malaysia," vol. 2012, 2012.
- [7] S. S. M. and A. H. M. Amer Mejbil Ali, "Design optimization of solar power system with respect to temperature and design optimization of solar power system with respect to temperature and sun tracking," 2016 Al-Sadeq Int. Conf. Multidiscip. IT Commun. Sci. Appl. – IRAQ May, no. May 2015, 2016.
- [8] N. Chowdhury, C. A. Hossain, M. Longo, and W. Yaïci, "Optimization of solar energy system for the electric vehicle at university campus in Dhaka, Bangladesh," *Energies*, vol. 11, no. 9, pp. 1–10, 2018.
- [9] T. Ma, H. Yang, L. Lu, and J. Peng, "An Optimization sizing model for solar photovoltaic power generation system with pumped storage," *Energy Procedia*, vol. 61, pp. 5–8, 2014.
- [10] A. Ghafoor and A. Munir, "Design and economics analysis of an off-grid PV system for household electrification," *Renew. Sustain. Energy Rev.*, vol. 42, pp. 496–502, 2015.
- [11] A. Alahmed, S. I. Sidiki, Y. Alharthi, G. M. Chaudhry, and M. K. Siddiki, "Design, simulation and financial analysis of stand-alone photovoltaic system at university of Missouri-Kansas City, Missouri, USA," pp. 3287–3291, 2016.
- [12] Ministry of Science and Technology Data.

- [13] G. A. C. (DLR) I. of T. Thermodynamics and S. S. A. and T. Assessment, "Concentrating solar power for the Mediterranean region, executive summary," MED-CSP, 2005.
- [14] A. B. Barnawi and Submitted, "Hybrid PV/wind power systems incorporating battery storage and considering the stochastic nature of renewable resource," no. August 2016.
- [15] C. P. N. A. and B. C. I. F. I. Nwabuokei, "Design of a stand-alone photovoltaic power system: case study of a residence in ogwashi-ukwu, delta state," *Academic Discourse: An International Journal*, 2014.
- [16] F. H. F. and M. A. E.-S. Amal A. Hassan and 1Electronics, "Stand-alone photovoltaic system for an emergency health clinic," *International Conference on Renewable Energies and Power Quality (ICREPQ'10)*, 2010.
- [17] F. Sick and T. Erge, "Photovoltaics in buildings - a design handbook for architects and engineers," International Energy Agency, Paris, France, XYZ Publishing Company, 1996.
- [18] G. E. Ahmad, "Photovoltaic-powered rural zone family house in Egypt," *Renewable Energy*, vol. 26, pp. 379–390, 2002.
- [19] M. M. E. Ali, "A visual basic-based tool for design of stand-alone solar power systems," *Energy Procedia, TerraGreen 13 International Conference*, vol. 36, pp. 1255–1264, 2013.