

Aseel B. Abdul-Hussein

Materials Engineering
Department, University of
Technology, Baghdad, Iraq.

Emad S. AL-Hassani

Materials Engineering
Department, University of
Technology, Baghdad, Iraq.

Marwa Subhi

Materials Engineering
Department, University of
Technology, Baghdad, Iraq.
Eng_merwa198822@yahoo.com

Received on: 11/05/2016

Accepted on: 29/09/2016

Effect of Nano Carbon Tube on the Mechanical and Physical Properties of Composites Based on Resin Route

Abstract- In this work, the physical and mechanical properties of nano composites are investigated. The nano composites consist of matrix was polyester resin and 3% volume fractions of glass fibers as reinforcement with (0.5%, 1%, 1.5%, 2 %) volume fractions of carbon nanotube as filler. Samples of nano composite materials in this research have been prepared by hand – layup. The results showed that the sample (UP+3% GF) has higher water absorption than sample net polyester. As can be noted from the results that the sample (UP+3% GF+2% CNTs) has higher value water absorption than other samples. Also can be observed from the results that the sample (UP +3%GF+0.5 CNTs) has high values of hardness (shore D), flexural strength, impact strength and fracture toughness from other (1%, 1.5%, 2%) volume fraction carbon nano tube.

Keywords- Nano Composites, Carbon Nanotube, Glass Fiber.

How to cite this article: A.B. Abdul-Hussein, E.S. AL-Hassani and M. Subhi, "Effect of Nano Carbon Tube on the Mechanical and Physical Properties of Composites Based on Resin Route," *Engineering and Technology Journal*, Vol. 36, Part A, No. 4, pp. 410-416, 2018.

1. Introduction

Nano composites are composites in which at least one of the phases shows dimensions in the nanometer range. Almost all types of polymers, such as thermoplastics, thermosets and elastomers have been used to make polymer nano composites. A range of nano reinforcements with different shapes have been used in making polymer nano composites. Carbon nanotubes (CNTs) possess high flexibility, low mass density, and large aspect ratio (typically ca. 300-1000). CNTs have a unique combination of mechanical, electrical, and thermal properties that make nanotubes excellent candidates to substitute or complement the conventional nano reinforcements in the fabrication of multifunctional polymer nano composites. Carbon nanotubes are hexagonally shaped arrangements of carbon atoms that have been rolled into tubes. Carbon nanotubes are allotropes of carbon with a cylindrical nanostructure [1]. There are many studies about composite materials. L.Merad.et.al, study the mechanical properties of nano composite that consist of epoxy resin reinforced with TiO₂ nanoparticles. These nanoparticles have (21nm) in diameter and volume fraction (0.5, 1, 5 and 20%). The results show that the mechanical properties of nano composite such as hardness and tensile strength higher than net epoxy and increased with increase addition of TiO₂ nanoparticles [2].

Rahman et.al, study thermal and mechanical properties of woven glass fiber / multi- walled

carbon nanotubes (CNTs) reinforced epoxy matrix. The result showed that the flexure test confirmed that the growth of 0.62wt % CNTs increased flexure strength and modulus of the glass fiber reinforced epoxy matrix by 16.5% and 13.2% respectively than the neat epoxy sample [3].

2. Experimental Work

The materials that are used in the preparation of samples consisting of woven glass fiber, polyester resin as the matrix with density of (1.11 gm / cm³) and multi-walled carbon nanotube [4].

The dimensions required of molds for preparing the specimens were made from glass (120×120×5) mm as shown in Figure 1.

The mean grain size of carbon nano tube was (48) nm, as shown in Figure 2.

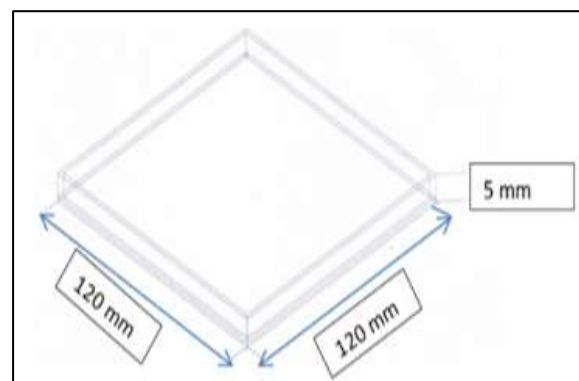

Figure 1: Illustration of the prepared mold sketch

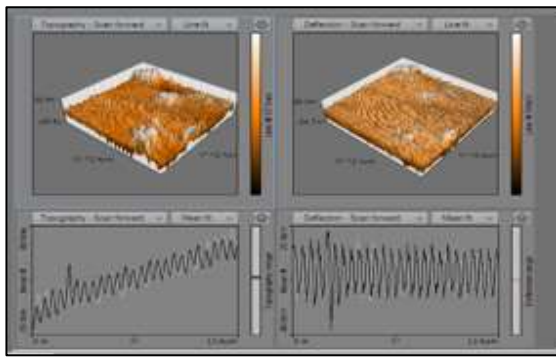

Figure 2: Atomic Forcing Microscope of Nano Carbon Tubes (CNTs)

I. Raw Material

The properties of material used in preparation of nano composites material are listed in Table 1. The X-Ray Diffraction pattern confirmed that (CNT) powders are shown in Figure 3. High intensities of Sharpe peaks could be obtained indicating a high Crystalline in the synthesized powder. All peaks could be indexed to a hexagonal structure.

Table 1: Properties of Material Used in the Work

Materials		Properties		
Polyester	Density	Tensile strength (65)MPa	Flexural strength	Viscosity
	(1.11) gm/cm ³		(110) MPa	(1.0) poise
E-glass	Density	Tensile strength (3445) MPa	Compressive strength	Young modulus
	(2.58) gm/cm ³		(1080) MPa	(72.5) Gpa
Carbon Nano Tube	Density	Tensile strength (150) GPa	Particle size	Young modulus
	(1.7) gm/cm ³		(48) nm	(1200) Gpa

II. Nano Composites Preparation

Nano composites samples were prepared from polyester reinforced with (3%) volume fraction of glass Fiber and carbon nanotube with volume fraction of (0.5 %, 1%, 1.5%, 2%). The method used for preparation the samples in this work is Hand lay-Up Molding. The nano composites are prepared according to the following steps:

- 1- Preparation of glass fibers woven of dimensions (120 × 120) mm according to the dimensions of the mould. The used volume fractions are (3%).
- 2- Weighing the reinforcing powder to specify a volume fraction of (0.5%, 1%, 1.5%, and 2%).
- 3- Weighing the polyester depending on the volume fraction of reinforcement materials (fiber and powder), while taking into consideration the weight of hardener.
- 4- The polyester is mixing with the hardener slowly and continuously by using a glass rod in order to avoid bubbles at room temperature.
- 5- The powder is adding gradually into the mixture and stirring it to obtain homogeneity for a period of (10-15) minutes. A rise in the temperature of the mixture will result as an indication to the beginning of the interaction process. It is very important that the mixture must have a good viscosity for protecting the particles from precipitation, which may result in the heterogeneity of the mixture that leads to the agglomeration after hardening.
- 6- Pouring the mixture into the mould, then putting the glass fiber mat into the mould and continuing of mixture pouring until it covers the entire mat.
- 7- Pressing the mixture with an appropriate load.

8- For completing the process of hardening, finally is leaving the sample in the mould for a period of (24) hour at room temperature. Samples are then extracted from the mould and then heat treated in an oven at (60C°) for a period of (60) minutes. This process is very important for obtaining the best cross-linking between polymeric chains, and to remove the stresses generated from the preparation process and complete the full hardening of the samples [5].

III. Mechanical Test

1. Hardness Test Measurement:

This test is performed by using hardness (Shore D) and according to (ASTM D-2240) standard [6]. Specimens have been cut into a diameter of 40mm and a thickness of 5mm. Figure 4 appears standard specimens for this test [6]. Figure 5 shows hardness device used in this research. For each specimen five hardness measurements were taken and the average hardness is calculated. Figure 6 show the prepared specimens

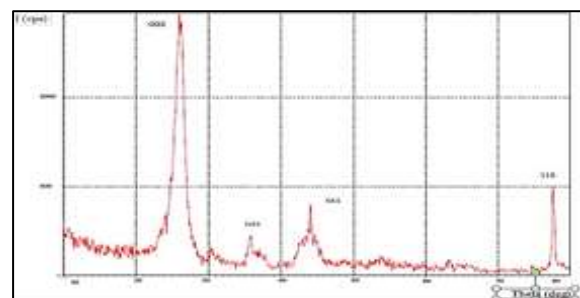

Figure 3: The X- Ray Diffraction of the CNTs Powder

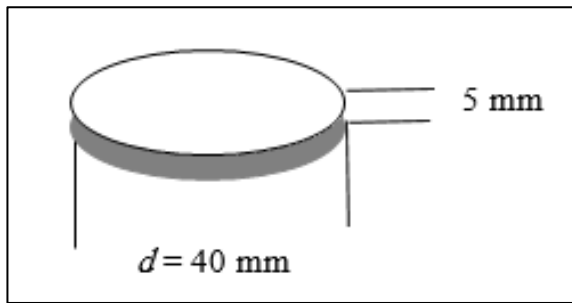

Figure 4: Hardness (Shore D) Standard Specimens [6]



Figure 5: Hardness Device



Figure 6: Prepared Specimens

2. Flexural Strength Test:

This test is according to ASTM D790 at room temperature. Specimens have been cut into the dimensions (100*13*4.8) mm. Figure 7 shows standard specimens for this test [7]. Figure 8 shows flexural strength device used in this research. The flexural strength is calculated according to the equations [8] Figure 9 show the samples before and after test.

$$F.S = \frac{3PL}{2BD^2} \tag{1}$$

Where F.S is the Flexural Strength (MPa). P is Force at Fracture (N). L is Length of the sample between Prediccate (mm) = 100mm. B is Thickness (mm) = 4.8 mm. and Dis Width (mm) = 13mm.

3. Impact test

The impact tests of specimens were prepared according to (ISO-180 standard) [9]. Impact resistance is calculated for samples from the following relationship [10]. Samples have been cut into the dimensions (80*10*4) mm as shown

in Figure 10. Figure 11 shows impact strength device used in this research. Figure 12 show the samples before and after test.

$$G_c = U_c / A \tag{2}$$

Where

G_c = Impact Strength of material (KJ/m²).

U_c = Impact Energy (J).

A = Cross- Sectional Area of specimen (m²)

Fracture toughness can be expressed as.

$$K_c = \sqrt{G_c E} \tag{3}$$

Where:

K_c = Fracture Toughness of material (MPa.m^{1/2}).

E = Elastic Modulus of material (MPa).

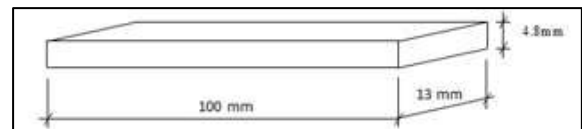

Figure 7: Flexural Strength Standard Specimen [7]



Figure 8: Flexural Strength Device

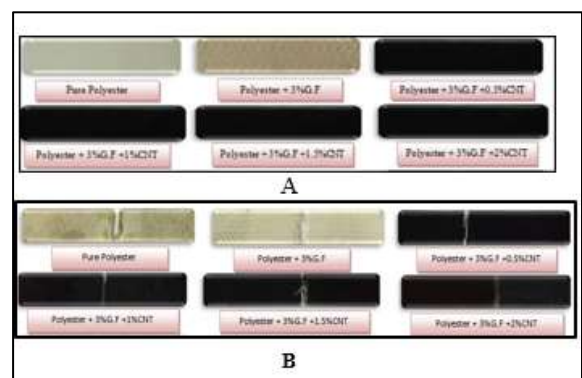

Figure 9: Prepared Specimens (A) before Test (B) after Test

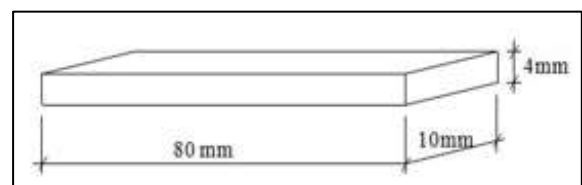

Figure 10: Impact Test Standard Specimens [9]



Figure 11: Impact Test Device

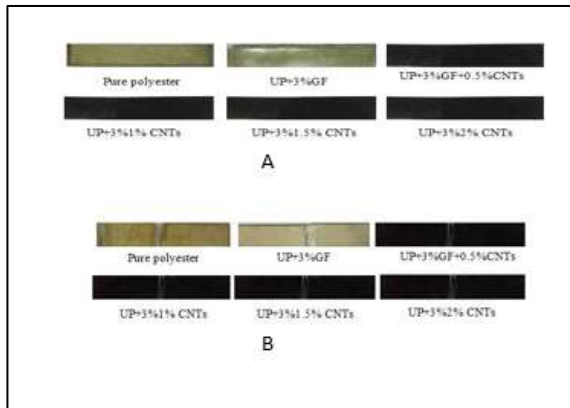

Figure 12: Prepared Specimens (A) before Test (B) after Test

3. Physical Tests

Water Absorption

The water absorption test is performed according to ASTM D 570 standard at room temperature [11]. Specimens have been cut into a diameter of 40mm and a thickness of 5mm. The mechanism of water absorption is explained to be the direct uptake and flow of water by capillary and transport along the reinforcement-matrix interface [12]. Water absorption percentage is calculated using (Archimedes base) according the following formula [13], Figure 13 shows standard specimens for this test.

$$M (\%) = \frac{(m_t - m_0)}{m_0} \times 100$$

(4)

Where

M (%): water absorption percentage.

m_0 : mass of specimen before immersion (g).

m_t : mass of specimen after immersion for seven days (g).

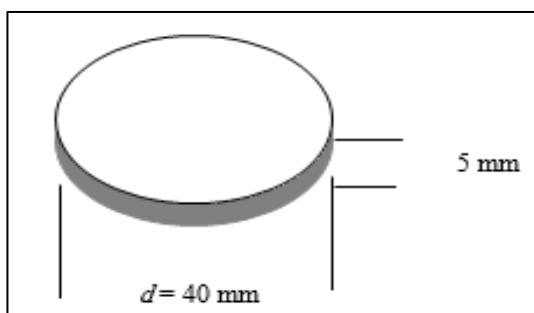

Figure 13: Standard Specimens [11]

4. Results and Discussion

I. Hardness Shore (D)

Hardness test type (Shore (D)) has been carried out on pure polyester before and after glass fiber and Nano fillers were added and the average of five readings in each case was taken to obtain higher accuracy results. Table 2 lists the values of hardness for the prepared (Pure polyester, polyester +3% glass fiber and CNT) composites. From Figure 14 show the increased in fiber content leads to an increase in the hardness, the value of hardness improved with the addition of volume fraction of fiber glass because of their chemical consensus between fiber and polyester resin [14]. The addition of the fiber leads to an increase in the elasticity and a decrease in the matrix surface resistance to the indentation, thus specimen (polyester+3%G.F) have higher hardness than specimen (pure polyester). It can be seen from figure a pronounced effect of the addition of 3% glass fiber with 0.5%, 1%, 1.5% and 2% volume fraction from (CNT) the hardness of the material. The hardness decreases with increasing volume fraction of carbon tube. Result had revealed that the hardness of pure polyester alone was (77 shore D) compared to maximum value (84.3) at volume fraction of (0.5% CNTs) with particle size is (48nm).

The reason of the increase in hardness is that CNTs contains an element harder than the pure polyester that lead to an increase in hardness than pure polyester but the hardness decreases with increased volume fraction of carbon nanotube because the CNTs increase elasticity.

II. Flexural Strength

Table 3 list the values of flexural strength for the prepared (pure polyester, polyester +3% glass fiber and CNT) composites. From Figure 15 it can be see that there is a clear influence on the value of flexural strength when adding 3% volume fraction of fiber glass than sample pure polyester, also can be seen that the flexural strength decreases with increasing volume fraction of carbon nanotube. The increasing volume fraction of (2% CNTs) cause to increasing in viscosity and agglomeration of CNTs Wight has contributed to the drop in the flexural properties of composite [15]. Flexural strength of pure reference polyester was (150 MPa) then an increasing had observed with increasing in volume fraction until it reached to its maximum value of (202MPa) by the addition

of (3% glass fiber) and volume fraction of (0.5%CNTs).

Table 2: Hardness Shore (D) of Nano Composites

Types of composite	Hardness Shore (D)
Pure polyester	77
polyester +3% Glass fiber	79
(Nano Composites)	
polyester +3%GF+0.5% CNTs	84.3
polyester +3%GF+1% CNTs	83.2
polyester +3%GF+1.5% CNTs	82.2
polyester +3%GF+2% CNTs	81

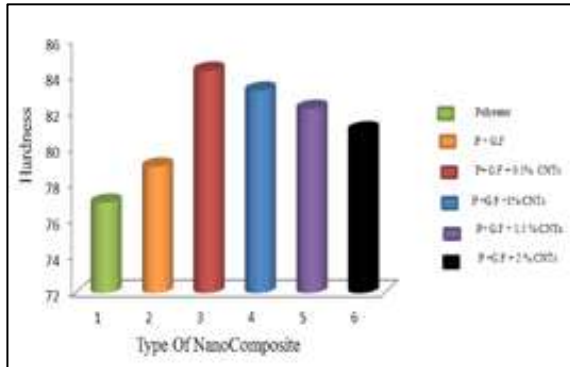

Figure 14: Hardness Shore (D) of Nano Composites

Table 3: Flexural Strength of Nano Composites

Types of composite	Flexural Strength (MPa)
Polyester	150
polyester +3% Glass fiber	175
(Nano Composites)	
polyester +3%GF+0.5% CNTs	202
polyester +3%GF+1% CNTs	198
polyester +3%GF+1.5% CNTs	191
polyester +3%GF+2% CNTs	183

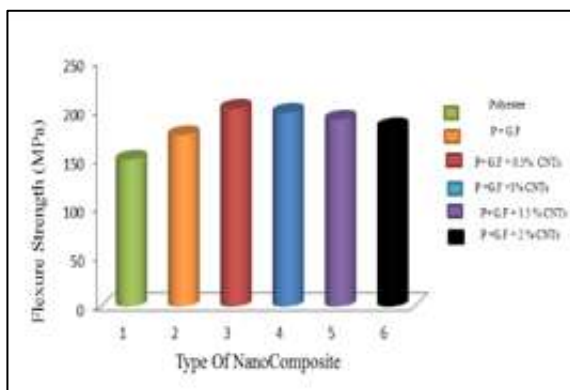

Figure 15: Flexural Strength of Nano Composites

III. Impact Energy

Tables 4 and 5 and Figures 16 and 17 shows the values of impact strength (G_c) and fracture toughness (K_c) for the prepared (pure polyester, polyester +3% glass fiber and nano carbon tube) composites. The results of (G_c) & (K_c) for pure polyester are lower than that of Nano composites. The reinforcements affect positively in bearing

impact load and increasing the impact energy required to fracture the specimen. Impact strength of pure reference polyester was ($1000 J/m^2$) the increase is observed with increasing in volume fraction till it reached to its maximum value of ($1500 J/m^2$) by the addition of (3% glass fiber) and volume fraction of (0.5%CNTs). From the results the increase volume fraction of CNTs decrease the value of impact strength and fracture toughness, the decrease in the values at 2% CNTs may be attributed to the increased brittleness and crystallinity in the Nano composites which restricts the movement of polymer chains.

This causes microcracks when impact occurs, causing easy crack propagation. Therefore, the higher agglomeration CNTs can cause the mechanical properties of the nano composites to decrease [16].

IV. Water Absorption

Figure 18 shows the water absorption of all prepared composites can be seen the specimen (polyester +3%G.F) have higher water absorption than specimen (pure polyester). 3%G.F+0.5% CNTs) have lower than specimen of other specimens. The increasing water absorption percentage with increasing volume fraction of fiber depends on the rule of mixture theory where fiber has a higher water absorption percentage than specimen pure polyester [17]. The water absorption attacked the fiber-matrix interface, causing de-bonding of the fiber and the matrix. The failures of the composite materials were due to voids [18].

Table 4: Impact Strength of the Prepared Composites

Types of Composite	Impact Strength (J/m^2)
Polyester	1000
polyester +3% Glass fiber	1200
(Nano Composites)	
polyester +3%GF+0.5% CNTs	1500
polyester +3%GF+1% CNTs	1480
polyester +3%GF+1.5% CNTs	1410
polyester +3%GF+2% CNTs	1302

Table 5: Fracture Toughness of the Prepared Composites

Types of Composite	fracture Toughness ($MPa.m^{1/2}$)
polyester	8.95
polyester +3% Glass fiber	10.85
(Nano Composites)	
polyester +3%G.F+0.5% CNTs	18.230
polyester +3%G.F+1% CNTs	16.873
polyester +3%G.F+1.5% CNTs	14.650
polyester +3%G.F+2% CNTs	13.763

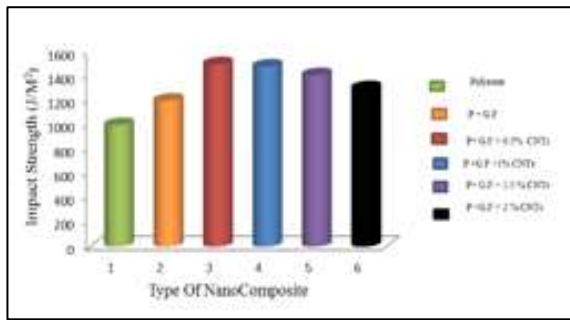

Figure 16: Impact Strength of Nano Composites

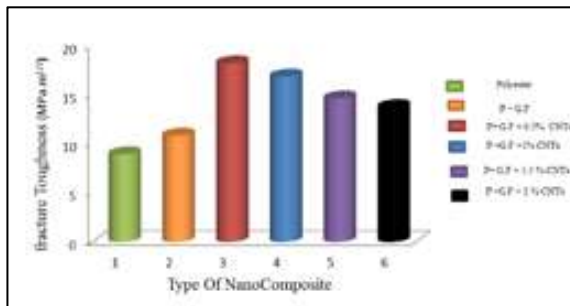

Figure 17: Fracture Toughness of Nano Composites

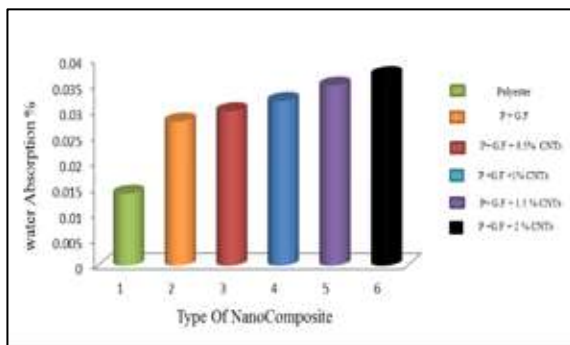

Figure 18: Water Absorption of Nano Composites

5. Conclusions

1. Non-reinforced pure polyester has lower physical and mechanical properties than (polyester+3%glass fiber) composites and nano composites.
2. Result shows that the best hardness value was (84.3 shore D) at sample (UP+3%GF+0.5% CNTs).
3. The sample (UP+3%GF+0.5% CNTs) has value flexural strength (202MPa).
4. Impact strength and fracture toughness at volume fraction of (3%glass fiber) with (0.5% CNTs) have the value (1500 J/m^2), ($18.230 \text{ MPa.m}^{1/2}$) respectively.
5. The values of water absorption of specimen (pure polyester) lower than specimen (UP+3% GF). Nano composite with 3% GF and 2% CNTs have the higher water absorption when compared with specimen (UP) and specimen (UP +3% GF) composites. Nano composite with (UP +3% GF +2%CNTs) has the maximum water absorption of (0.037%).

References

- [1] J. Cuppoletti, "Nano composites and Polymers with Analytical Methods," Publisher in Tech, ISBN: 978-953-307-352-1, 2011.
- [2] L. Merad, B. Benyoucef, M.J.M abadie, J.P charles, "Characterization and Mechanical Properties of Epoxy Resin Reinforced With TiO_2 Nanoparticles," Journal and Engineering and Applied Sciences, No. 3, PP.205-209, 2011.
- [3] A.S. Rahman, V. Rangari, S. Jeelani, "Thermal and Mechanical Properties of Woven Glass Fiber Reinforced Epoxy Composites with Carbon Nanotubes Grown in-Situ," The International Journal of Engineering and Science (IJES), Issue. 12, Vol. 4, PP .54-61, (2015).
- [4] Intelligent Materials Pvt. Ltd, nanoshel2@gmail.com, web: www.nanoshel.in, 3422Old Capitol Trail Suite 1305, Wilmington DE-19808US.
- [5] k. Felix, A. Sylvester and A. Edmund, "Storage and handling techniques of maize and groundnut," Senra Academic Publishers, Burnaby, British Columbia, No. 3, Vol. 6, PP.2122, 2012.
- [6] Annual Book of ASTM Standard "Standard Test Method for Plastics Properties- Durometer Hardness D 2240," Vol. 09.01, 1988.
- [7] Annual Book of ASTM Standard, "Standard Test Methods for Flexural Properties of Unreinforced and Reinforced Plastics D 790- 86," Vol. 10.01, 1986.
- [8] A.I. Al-Mosawi, M.A. Rijab, N. Abdullah, S. Mahdi, "Flexural strength of fiber reinforced composite," International Journal of Enhanced Research in Science Technology and Engineering, Issue 1, Vol. 2, 2013.
- [9] Standard Test Method for Izod Impact (Unnotched) ASTM D4812, ISO180", 2014.
- [10] D.R. Askeland, P.P.Fulay and W.J. Wriht,"The Science and Engineering of Materials", 6th edition, Cengage Learning Inc., 2011.
- [11] Annual Book of ASTM Standard, "Standard Test Method for Water Absorption of Plastics D 570- 98," Vol. 08.01 2005.
- [12] M. Ismail, S. Bheemappa and N. Rajendra, "Investigations on Mechanical and Erosive Wear Behavior of Chemosphere Filled Carbon-Epoxy Composites," International Conference on Mechanical, Automotive and Materials Engineering, Dubai, pp.209, 2012.
- [13] A. Kalil, "The Effect of Particles as Additives on Water Absorption for Epoxy Resin," International Journal of Application or Innovation in Engineering & Management, Issue 5, Vol.2, PP.131-136, 2013.
- [14] F.O. Abas, R.O. Abas and S. I. Ibrahim, "A Comparison Study of Different Ceramic Filler on Mechanical and Thermal Properties of Glass, Carbon, Kevlar / Polyester Composites," Eng. & Tech. Journal. , No.12, Vol.28, 2010.
- [15] D.S. Jebadurai and A.S. Babu "Influence of functionalized multi - walled carbon nanotubes on mechanical properties of glass fiber reinforced polyester composite," Indian Journal of Engineering and materials Sciences, Vol.22, PP.167-174. 2015.

[16] A. Peigney, C. Laurent, E. Flahaut, R. R. Bacsa, and A. Rousset, "Specific surface area of carbon nanotubes and bundles of carbon nanotubes Carbon," No. 4, Vol. 39, PP. 507–514, 2001.

[17] D. Chandramohan, and J. Bharanichandar "Natural Fiber Reinforced Polymer Composites for Automobile Accessories," American Journal of Environmental Science, No.6, Vol. 9, PP. 494-504, 2013.

[18] W.A. Zkaer "Determination of Some Mechanical Properties of Unsaturated Polyester Reinforced with Glass Fiber and Palm Fiber," Eng. &Tech. Journal, No.16, Vol.29, pp.3313-3319., 2011.