

Adil SH. Jaber 

Affiliation Department of
Production Engineering and
Metallurgy / University of
Technology Address City,
Country Baghdad Iraq
70218@uotechnology.edu.iq

Received on: 18/04/2018
Accepted on: 13/09/2018
Published online: 25/12/2018

Investigation of The Effect of Loading Paths in the Tube Hydroforming Process

Abstract- The control accurately of internal pressure, axial feeding and paths of loading which have important influences on the final tube quality. In this research an impact of loading path of the tube hydroforming process and final part requirements (i.e. thickness specification and shape conformation) were studied numerically. Small bulge shape tube hydroforming parts were utilized in the finite element analyses to get several guidelines on the effect of the relation between the internal pressure and axial compressive feeding programs. Two dimension model of bulge shape tube (50 mm) bulge width has been developed from cylindrical tube with thickness (2mm) of the copper and (60 mm) outer diameter. A commercial available finite element program code (ANSYS 11), is used to perform the numerical simulation of the tube hydroforming operation. The results demonstrate that, the loading path has very important influenced on the thickness distribution over the tube and capability attained the target shape of the required product.

Keywords- Tube hydroforming, Process parameters effect, Finite element method.

How to cite this article: A.Sh. Jaber, "Investigation of the Effect of Loading Paths in the Tube Hydroforming Process," *Engineering and Technology Journal*, Vol.36, Part A, No.12, pp. 1236-1243, 2018.

1. Introduction

The hydroforming operations have a broad variety of exercises in the metal forming manufacture because of the fact that, with hydroforming and industrialist are able to manufacture the tube with very complicated shape, fewer welds than with traditional metal forming processes and lightweight, reduce cost of tooling, part consolidation on assemblies, very good materials employment, less number of processes, and enhanced part quality are advantages of hydroforming process [1, 2]. In the process of tube hydroforming, a tubular blank is shaped in a cavity of the die by applying of hydraulic internal pressure on the wall tube and axial compressive forces on the both ends of the tube as shown in Figure 1 [1,3]. Since the implementation of tube hydroforming process into mass production was relatively novel compared to other metal forming technology for example forging and stamping; existing information base, rules of design, and experience for design of part, process and tooling are limited. As a consequence; for this reason, use of these innovation to novel tubes requires broad advancement and try labors. Therefore, this prompts high capital cost, which makes the application of tube hydro forming operation is lesser competitiveness as compared with traditional metal forming [1]. At the beginning of the operation, excessive use of axial compressive feeding for a certain tube, result in buckling defect. Additionally, increasing of apply application of the

internal pressure may lead for bursting. Moreover, inadequate axial feeding on the end of the tube may result in decreasing of the thickness at regions of the tube which subject to large expansion that may not be satisfactory for performance requirements [4]. Fundamentals of this operation returns to 1939 when Grey et al. [5] presented research for manufacturing of seamless copper fittings with T bulges by applying of the internal hydraulic pressure and axial forces simultaneously. The hydroforming procedure obtain popularity after his study and specialists carried on more studies on this subject to manufactured tubes with complicated protrusions. Koc and Altan [6] introduced a general survey of the tube hydroforming procedure. This paper briefs a technological survey of hydro forming technology from its initial years to very modern years on different subjects for example tube hydroforming parts, technology, process, hydraulic and control system, materials and formability in THF, friction and evaluation lubrication, performing of tube for hydroforming process, at last advancements and directions in hydroforming innovation, so another researchers at different regions around the world can application it for further studies here. Ken-ichi Masaaki [7] concentrated on factors influenced wall thickness distribution of the hydroforming tube by experimental work and finite element simulation. LS-DYNA3D are utilized for

investigation of the hydroforming process of tubes. A model of this work involve plain hydroforming of a square expanded part from a cylindrical tube by using combined internal pressure and axial feed. Considered as variables, the ratio of stresses, friction coefficient, strain hardening exponent, and anisotropy parameter. The results demonstrate that axial feeding and best lubrication conditions enhance the thickness distribution, while the anisotropy parameter was one of the most significant materials parameters for tube hydroforming. It is figure out that location of the fracture of tube depends on process conditions and materials properties and is not confined to a free bulged portion. Experimental results utilizing an AL alloy tube (A6063) are in pretty harmony with FEM simulation experiments. Xu et al. [8] investigation mathematically the distribution of thickness along the square cross-sectional hydroforming part. Explored numerically the impacts of the (μ -value), (n -value) and the (R -value) on the thickness of the distribution, and the different regularity of the wall thickness. The results display that the thickness decreases gradually along the side wall from the middle points to the tangential points at the corner of a rectangular-sectional hydroformed part. The analytical and simulation outcomes demonstrate that the results are the same as those of the work tests. The simulation were performed using the LS-DANA software. Method of simulated optimization connected to a commercial FE code is presented by Seyedkashi, et al. [9] Examine of the impact of different geometrics of tube on the loading paths (relation between the internal pressure and axial feeding). In order to investigated the dimensions of tube on the optimized internal pressure and axial feed, kept all the variables process as constant in all experiments such as expansion ratio, lubrication condition and materials, then these results extracted from these experiments are compared with experimental work to validity of this method described above. Finally, the impact of tube geometry (diameter and thickness) on the optima; axial feeding and internal pressure, accuracy of final shape are presented. This unfamiliar method of optimization is used for metal forming process especially tube hydroforming based on Simulated Annealing algorithm. Because of the complex combinatory condition of loads in tube hydroforming, theoretical methods are not capable of determining the optimal loading paths. Based on the results obtained by this method for optimization of internal pressure and axial force in tube hydroforming, several guidelines are provided to help the designers estimate the appropriate

relationship between internal pressure and axial compressive feeding, with a constant initial diameter, corner fillet and expansion ratio, the increase of thickness results in less shape conformation, with a constant wall thickness, the increase in diameter results in better shape conformation, with a constant diameter, the increase in thickness should be compensated by increasing both internal pressure and axial force, with a constant thickness, the increase in diameter has more effect on axial force in comparison with internal pressure, the effect of thickness on needed axial feed and pressure is higher than that of initial diameter. Simulative analysis of THF process was discussed by sreenivasulu, Prasanthi, Kumar [10], free bulge shaped tube dies were modeled by using Auto CAD. Subsequently, the processes are simulated using DEFORM-3D and the experimental work verified with the simulation work under condition of the loading and proper boundary. Also study process parameters been conducted. They have been find that the estimated process parameters, developed height of protrusion and the distribution of wall thickness along different planes are in pretty coincidence with work tests. From different simulations carried out for free bulge shaped tubes, it could be reasoned that, so as to make a tube with moderately uniform wall thickness during the modern shape while largest bulging can be attained, it is very significant to choose the optimal radius of die, initial length of tube and adequate lubricates are used. From the different variable researchers, the wall thickness and the height of protrusion are very critical to internal pressure, lubrication, and axial compressive feeding.

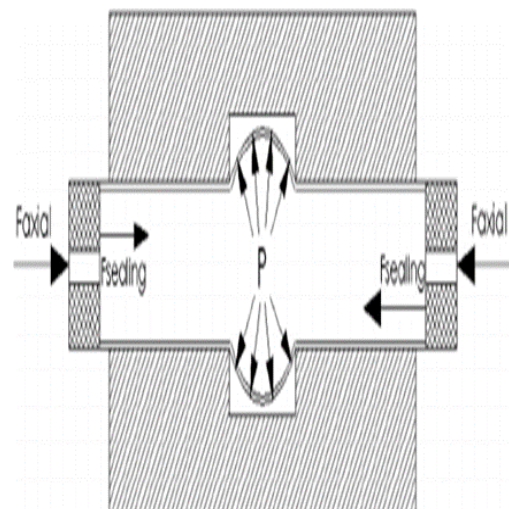

Figure 1 Tube hydroforming process

2. Experimental Work

In this work in order to simulate of tube hydroforming for tubular blank of copper material must be, introduce the materials properties for this material in the FEA. The mechanical properties values can be obtained by set of experimental work. The chemical composition of tube material were found out by spectrometry device in the state company for inspection and engineering Rehabilitation activities (S.I.E.R) / Baghdad and reported in the Table 1. The heat treatment operation was done of the tubular blank of copper material to improve the ductility property based on the results extracted from previous researches, the tube was annealing by heavy-duty electric furnace of type CWF 12/13. The annealing temperature considered for copper materials were 462°C, the holding time in the furnace was 75min and then cooled in the furnace, the specification of furnace included maximum temperature 1200°C, 3KW and 220V. Tensile test was done to determine the stress-strain curve for finding the mechanical properties values for the copper tube, which used in the numerical simulation. Specimens in the longitudinal direction of the tube for this test are cut directly from the tube by CNC machine in an ASTM E8 standard, the dimensions of tensile specimen as displayed in the Figure 2, then the specimen was fixed carefully by the special gripper which suitable for curvature surface of the specimen cut from tube on the universal testing machine, after that it loaded until fracture. This test was conducted under constant velocity of cross head of 10 mm/min using a WDW-200E tensile testing machine, which have capacity 200KN. The tensile test has been done in the University of Technology/ Baghdad, the universal testing machine used in this study as shown in Figure 3. The true stress-strain curve was concluded from engineering stress-strain curve that got directly from testing machine. The slope of linear elastic

region define the modulus of elasticity while the slope of the flow curve at specific level of stress (yield stress) is tangent modulus, the yield stress was evaluated by taking the 0.2% offset from this curve, while the passion ratio take from the standard tables. Mechanical properties for copper materials are shown in Table 2.

3. Numerical simulation

The numerical analysis has been a helpful tool through the years ago for traditional metal forming operations to get information have the accuracy and reliable around the material, process and geometry variables. Now a day's application of finite element method for tube hydroforming process simulations have become a standard development tool after that experimental validations and numerical investigations carried out by different researchers since the early 1990's and use of various finite element method software into tube hydroforming operations were carried out and displayed successfully. The feasibility of forming a given tube can be predicted by analyzing decreases of thickness, increases of thickness, and the values of strains and stresses on a final part, the impacts of various variables could be researched by changing the internal pressure and axial feeding, materials, process conditions on a given tube. In this manner guidelines could be setup for aftertime issues [11].For simulating the tube hydroforming processes, commercial finite element analysis software ANSYS11.0 was utilized, it was use the "Newton-Raphson" implicit way for solving nonlinear issue. In these processes, the internal pressure applied on the wall tube and axial feeding are defined explicitly through a time extend. Many solutions (substeps or time steps) are carried out to apply the pressure in a gradual way within each step. At every substep, a number of equilibrium iterations are carried out to get a solution which have converged.

Table 1: chemical composition of copper tube.

| Cu | Zn | Fe | C | Al | Ni | Sn | Mg | Pb | P | Ag | S |
|------|--------|--------|--------|--------|-------|------|---------|--------|--------|-------|--------|
| 99.9 | 0.0522 | 0.0126 | 0.0064 | 0.0025 | 0.004 | 0.01 | 0.00013 | 0.0077 | 0.0222 | 0.001 | 0.0021 |

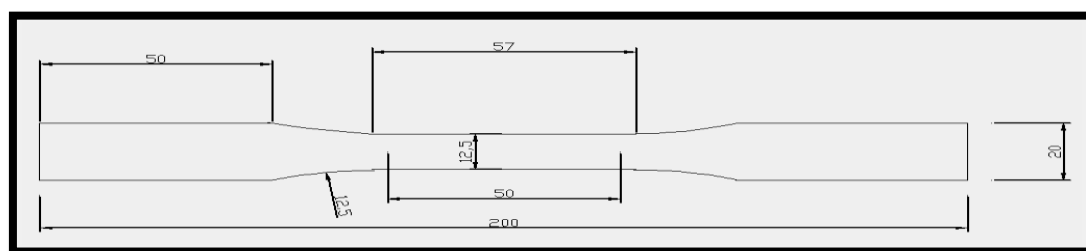

Figure 2: The dimensions of the tensile test specimen according to ASTM standard E8M specification.

Table 2: The material properties used in simulation of the tube hydroforming process.

| symbol | Parameters | value | unit |
|------------|-----------------|-------|------|
| E | Young's modulus | 118 | GPa |
| U | Passion ratio | 0.34 | – |
| σ_y | Yield stress | 57 | MPa |
| Et | Tangent modulus | 1.2 | GPa |

In this study, different case studies of tube hydroforming tubes with two dimension finite element analysis were introduced. Two-dimension 2-D 4-node structural solid axisymmetric element (PLANE42 2D LARGE STAIN SOILD) was used for tube (tubular blank). The tool set (punches to provide the axial feeding in the end *sides* and die) was modeled as rigid bodies. Element sizes are controlled by controlling the partition specification of lines. The accuracy of the results are affected by the density of the mesh of the die, punch and tubular blank. So the meshes in the tubular blank are softer. The most imperative regions of the tool whose mesh intensity influenced the accuracy and reliability of the results is its arc section and the meshes of this portion are softer than other portions. The movement of the punch for axial feeding was defined using a pilot node. The DOF of the pilot node represent the movement of the full rigid surface. Automatic contact step in ANSYS11.0 was exercised to model the complex interaction between the blank and tooling. For rigid tool set-flexible blank contact, target elements of TARGE196 was utilized, to explain 2D target punch, die and blank holder surfaces that were related with the deformable body blank represented by 2D 8-node contact elements of CONTA175. The target and contact surfaces constitute a "contact pair" that were utilized to explain a sliding and a contact between the tools and blank. A tube hydroforming model was created. Due to the symmetry in the specimen geometry, constraints and boundary conditions, two dimensional (2D) model needed was analyzed. For simplifying the simulation of this process, the subsequent hypotheses were made: temperature of workpiece (tubular blank) stayed stationary, there are not heat transmits from blank to the tools, the dies are rigid. Bilinear isotropic hardening BISO option utilizes the von Mises yield criterion mixed with an isotropic work hardening assumption. This choice was usually preferred for large deformation analysis. The principal axes of anisotropy coincide with the material (or element) coordinate system. Elasto-plastic constitutive model with isotropic

strain hardening were utilized to simulate the tube response. The elastic behaviors were taken to be linear and the plastic behaviors were modeled utilizing the von Mises yield criteria, the friction coefficient is assumed to be uniform and constant for all contacting surfaces and equal to 0.1. Figure 4 shows the FE simulation of the forming sequences for the tube throughout the forming to reached to the target shape for final product (die cavity shape conformation) with axial feeding.

**Figure 3: The tensile test machine used.**

4. Result and Discussion

In tube hydroforming process, the parts with hollow which have different cross section areas can be done by applying the internal pressure of the hydraulic and additional axial compressive which leads to force a tube (blank) to conform to a given die cavity shape. In this study, tubular blank is having an outer diameter of 62 mm and thickness 2 mm is placed fitting in the die which have square cavity with flat base, the entry radius of die is $R_e = 6$ mm and the corner radius of the base of protrusion of $R_c = 2$ mm. The schematic illustration of tube hydroforming process as shown in Figure 5 and Table 3 illustrates the geometric parameters process used in the simulation. Variation in thickness from center to the edge of tube wall was examined in numerical simulation, it shown in Figure 6a. It clearly seen that tube wall get on thinning at bulge region (in the middle of the tube) due to subject the metal in this region to maximum bulging during the forming process, after this region the tube wall get excessive thinning at nearly (20-40) mm from tube center due to subject the metal in this region to excessive deformation in order to form the corner part of the bulging region, and then the thickness increases toward the tube edge because of its low deformation was occurred in this region, the thickness remains almost constant in the regions which the tube wall be in direct connect with the

surfaces of the die during the progress of the forming process while the wall gets thickening at outer edges due to compressive stresses. The change in thickness in the middle of the tube (tube pole) throughout the forming process shown in Figure 6b, it is obviously the thinning in the tube pole increases throughout the forming process due to increase in the internal pressure applied which it cause additional stretching of the tubular blank during the progress of the process, the thickness was reduced from 2mm (initial thickness of tube) before forming to 1.862mm (final thickness) for the middle point of the tube at the end the process. The effect of the loading path (the relation between the pressure inside the tube and axial

feeding) on tube hydroformed was discussed, due to effect the combinatory conditions of loading in tube hydroforming process it is difficult to determine the accurate result between of the effect of the internal pressure and axial feed, therefore, discussed two cases in the tube hydroforming technology, first case without axial feed and other case with axial feeding, to avoid the effects of tube dimensions, time, material parameters and fillet radii, these parameters was kept constant in all cases in order to find the effects of axial feeding pressure and internal hydraulic pressure on the wall thickness and shape conformation of the final tube.

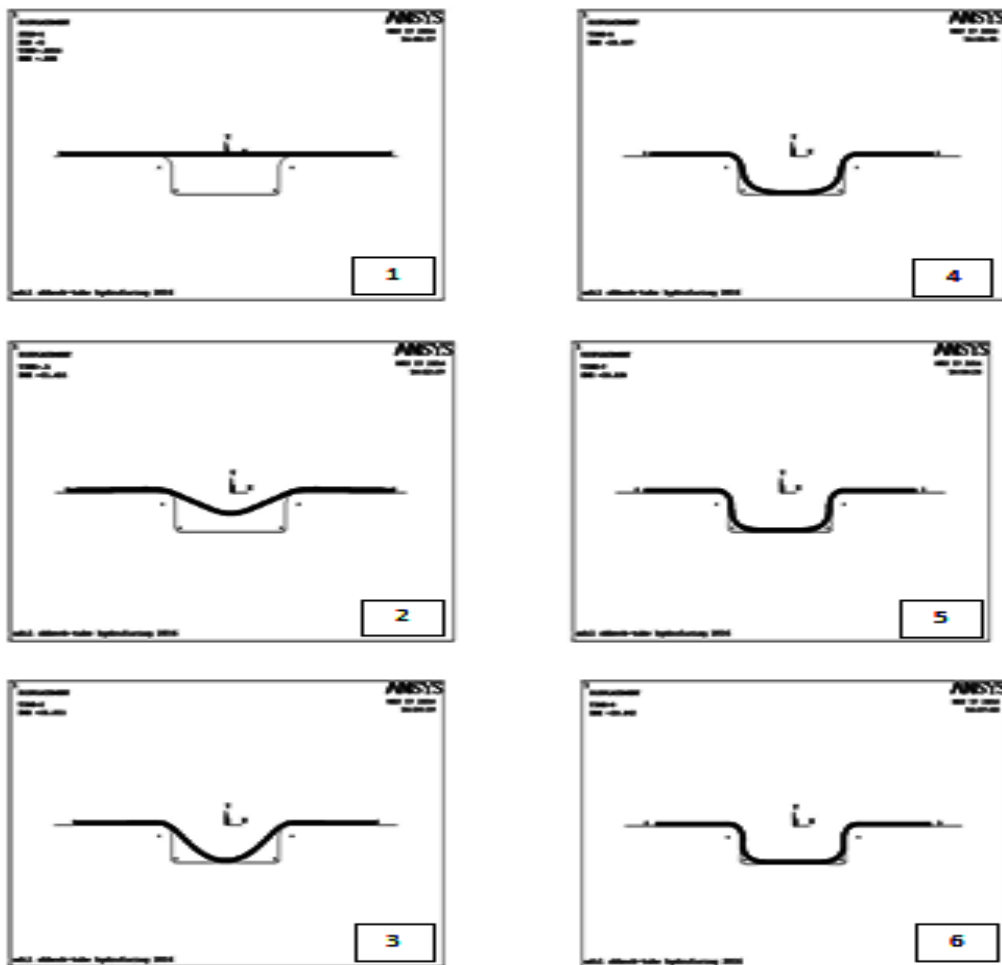

Figure 4: Different stages of material deformation during simulation in tube hydroforming process.

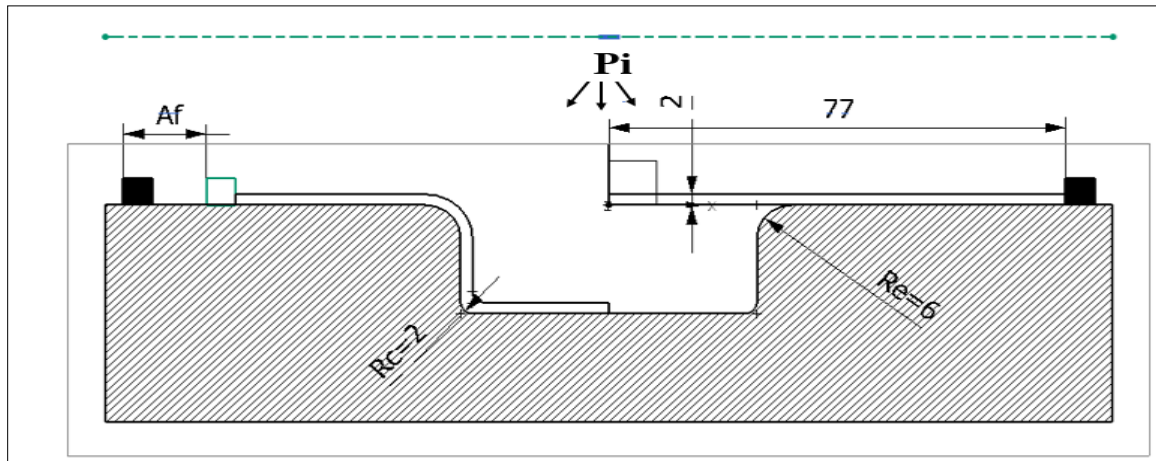

Figure 5: Representation of the tube hydroforming process

Table 3: The tube dimensions and process conditions used in this study.

| symbol | parameters | value | unit |
|--------|-------------------------|--------|------|
| T | Thickness of tube | 2 | mm |
| L | Length of tube | 154 | mm |
| D | Outer diameter of tube | 62 | mm |
| W | Bulge width | 50 | mm |
| Re | Fillet (entry) radius | 6 | mm |
| Rc | Corner radius | 2 | mm |
| Af | Axial feeding | 0, 7.5 | mm |
| μ | Coefficient of friction | 0.1 | |

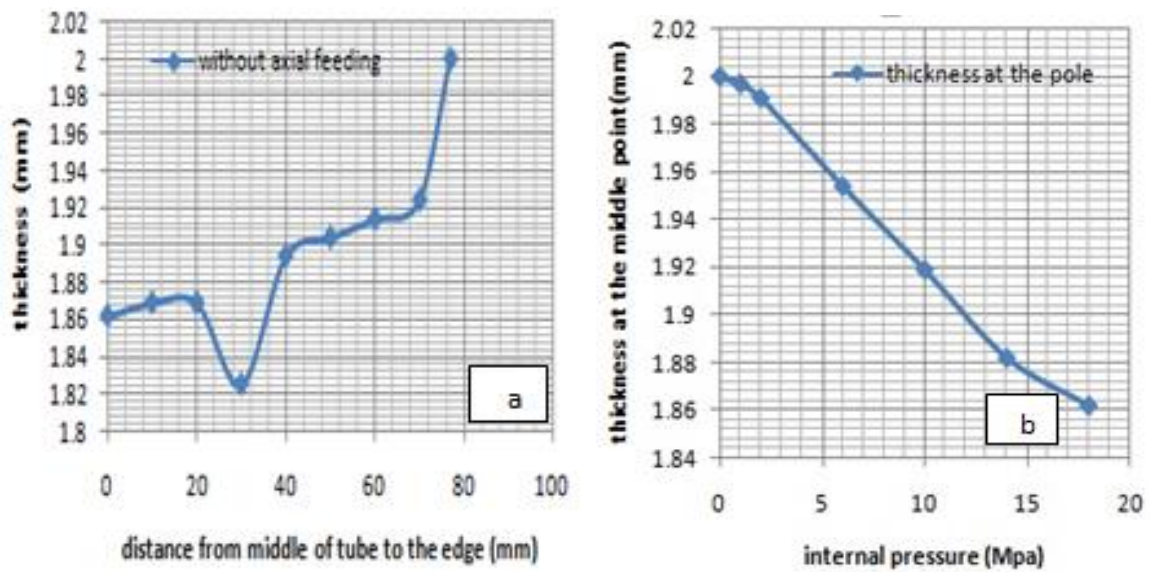

Figure 6: The thickness distribution on the tube wall. 6a, thickness distribution from middle to the edge tube. 6b, variation in the pole thickness during the hydroforming process.

Figure 7, is explain the variation in thickness in two cases (without axial feeding and with axial feeding value of 7.5mm over tube wall from middle to the edge of the tube), it is clearly two curves have similar trend, the maximum decreasing in thickness would take place in the mid of the part where the largest bulge occurs and it is observed from the Figure 7 decrease in thickness in tube wall with axial feed case is less than found without axial feed case because of the compressive axial feeding improves flow the metal into free bulge region, therefore the thinning decreased in this region. Figure 8 shows the effect of loading path on shape conformation, it is clearly from the figure the best tube to die shape conformation when use axial feeding because of the use of the axial feeding improves the flow of the metal in to the die cavity and therefore helping to reach to the required shape while the case of without axial feeding there are high difference between the tube produced and target tube therefore the tube hydroforming process without axial feeding has the least shape conformation in this study. Figure 9 shown the stages of deformation of the blank tubular over the time span during of the forming process progress with axial feeding. One of the most important difficult which face it in the tube hydroforming with square cross section die is the formation of corners of the bulged region especial when the small corners required will lead to increase the internal pressure applied to reach to the die shape conformation in order to discuss this problem the difference between the required tube and produced tube in the two cases (with and without axial feeding) are shown in the Figure 10, it noted in case used axial feeding value (7.5mm) the error distance between the target shape (die cavity) and the tube formed at the corner radius region reached to 3.327mm, while in case don't used the axial feeding this distance reached to 9.95 mm under same conditions such as (internal pressure, materials parameters and process conditions).

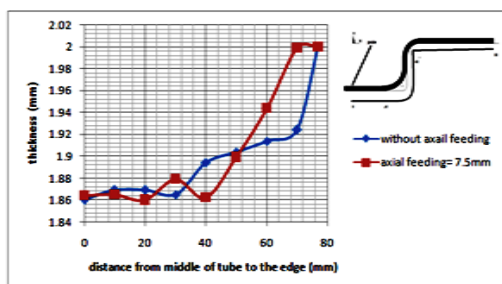

Figure 7: The variations in thickness on the tube wall from middle tube to the edge, for two cases (without axial feeding and with axial feeding value (7.5mm)).

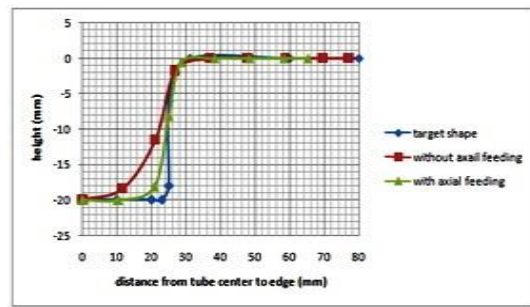

Figure 8: Shape conformation of the final tube from center to the edge after forming process.

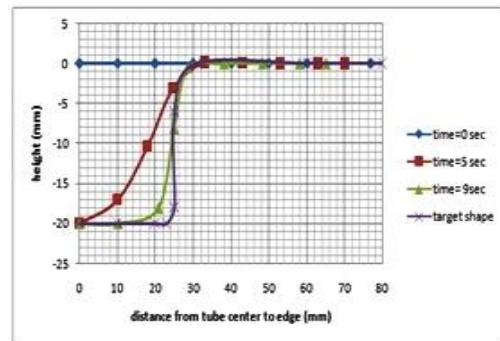

Figure 9: Shape conformation of the tube from center to the edge throughout the forming process.

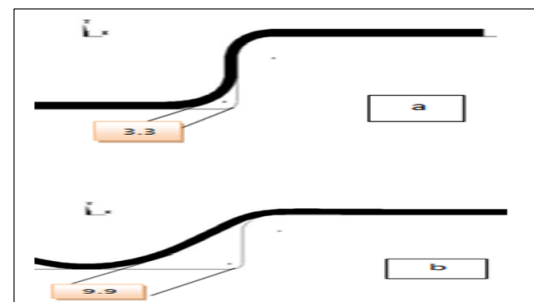

Figure 10: Shape conformation of the final tube at corner radius (a) with axial feeding, (b) without axial feeding.

5. Conclusions

The tube hydroforming process was simulated using finite element method with implicit formulation and using von miss yield criteria. It clearly form various simulations which conducted for bulge shaped tubes in the closed die cavity, the task is even very difficult because there are a lot of parameters affect on results, some of these parameters and their effect on shape conformation and thickness distribution were discussed in this study. It can be concluded, tube wall gets extensively thin during forming at bulge region (in the middle of the tube), the wall gets thicker at outer edges due to compressive stresses and remains almost constant wherever the part is in touch with the surface of the die. One of the

important parameters was loading path, it is noted, when we used the axial feeding the thickness distribution over the tube wall and shape conforming is better than in case don't used the axial feeding, because the compressive axial feeding will lead to improve the flow of materials from edge region to the bulge region, and error distance between dimensions of final tube required and formed tube is decreased when used axial feeding, especially in the sharp corner radius for the die.

References

- [1] M. Koc, "Investigation of the effect of loading path and variation in material properties on robustness of the tube hydroforming process," *Journal of materials processing technology*, Vol. 133, No.3, pp. 276-281, 2003.
- [2] A.R. Ismail and W. Saad, "Determination Formability of Tubular (AL-alloy) by Hydraulic Bulge Test," *Eng. &Tech. Journal*, Vol.34, No.2, pp. 246-256, 2016.
- [3] A.R. Ismail and S.A. Hammood, "Hydraulic Bulge Test of Al and Copper Tubes," *Eng. & Tech. Journal*, Vol.31, No.15, pp. 2941-2959, 2013.
- [4] M. Koc and T. Altan, "Prediction of forming limits and parameters in the tube hydroforming process," *International journal of machine tools & manufacture*, Vol.42, No.1, pp.123-138, 2002.
- [5] J. Grey, A. Devereaux and W. Parker, "Apparatus for making wrought metal," US patent, 2203868, June 3, 1939.
- [6] K. Koc and T. Altan, "An overall review of the tube hydroforming (THF) technology," *Journal of Materials Processing Technology*, Vol. 108, No.3, pp. 384-393, 2001.
- [7] K. Manabe and M. Amino, "Effects of process parameters and material properties on deformation process in tube hydroforming," *Journal of Materials Processing Technology*, Vol.123, No.2, pp.285-291, 2002.
- [8] X. Xu, S. Li, W. G. Zhang and Z. Lin, "Analysis of thickness distribution of square-sectional hydroformed parts," *Journal of Materials Processing Technology*, Vol.209, No. 1, pp. 158-164, 2009.
- [9] S.M.H. Seyedkashi, H.M. Naeini, G.H. Liaghat, M.M. Mashadi, M. Mirzaali, K. Shojaee and Y.H. Moon, "The effect of tube dimensions on optimized pressure and force loading paths in tube hydroforming process," *Journal of Mechanical Science and Technology*, Vol. 26, No. 6, pp. 1817-1822, 2012.
- [10] B. Sreenivasulu, G. Prasanthi and T. N. Kumar, "Simulative Analysis Of Tube Hydroforming Process," *International Journal of Research in Engineering and Technology*, Vol.2, No. 11, pp.756-763, 2013.
- [11] F. Qayyum, M. Shah, S. Ali and U. Ali, "Bulge hydroforming of tube by rubber mandrel without axial feed: Experiment and Numerical Simulation,"

Proceedings of the First International Symposium on Automotive and Manufacturing Engineering (SAME), Vol.1, No.7, pp. 19-26, 2015.

Author(s) biography



A.S.H. Jaber holds bachelors and master's degree in Production Engineering, from Department of Production Engineering & Metallurgy, University of Technology, Baghdad, Iraq. In addition, all my research published in journal of engineering technology