



Gaussian Process for GPS Receiver Predictor and INS /GPS Integration

Nawras K. Ahmed^a, Sameir A. Aziez^a, Ali Y. Khenyab^b

^a Electromechanical Engineering Dept, University of Technology-Iraq, Alsina'a Street, 10066 Baghdad, Iraq.

^b Mechanical Engineering Dept, Al-Salam university, Baghdad, Iraq

*Corresponding author Email: nawras93.kh@gmail.com

HIGHLIGHTS

- The GPS data values were predicted when a signal was cut off for any reason using the Gaussian Process algorithm.
- Synchronization between GPS values and INS values for integration was employed.
- Implementation of the work was done by the program MATLAB.
- The integration was carried out using the Extended Kalman filter.

ARTICLE INFO

Handling editor: Jawad K. Ali

Keywords:

GPS; INS; GP Predictor; loosely coupled; tightly coupled.

ABSTRACT

Global Positioning System (GPS) has become important and necessary in daily life. It is possible to reach any destination using GPS, which is included in many lands and marine applications. In this work, GPS was applied to a real navigation boat, integrated with the inertial navigation system (INS) device, and installed on the boat. The navigational devices were linked to the (mission planer) program, through which the results of the navigation process were shown. The system can provide better navigation performance accuracy and reliability due to the integration between GPS and INS. The data extracted from the navigation devices are processed using the Gaussian process (GP) prediction algorithm, to perform the GPS synchronization with the INS and predict the GPS cut-off values for specified periods. The prediction results of the GP algorithm are effective for the cut-off GPS data as the apparent error amount of the algorithm is low. In addition the inertial navigation system provides the location, speed, and position of the boat, but it contains a cumulative error that increases over time. On the other hand, the GPS better accuracy with a lower data rate than the INS, so the integration system between INS/GPS is necessary. It must be developed to overcome the negatives in both systems. Two types of integration were introduced and implemented herein: loosely and tightly. From the results obtained, one can see that the tight system is better at improving errors.

1. Introduction

The Global, Positioning System (GPS) is a satellite-based radio navigation system. Satellite system that can provide accurate three-dimensional location and velocity data to the customers of GPS receivers global in all climate conditions [1]. The triangulation of location is the basic theory of GPS. The coordinates of a point can be uniquely determined if the distances between three non-coplanar locations with known coordinates are supplied since the supplied information will consist of three equations to be solved for three unknowns. To compensate for receiver clock inaccuracy, GPS employs not three satellites; but four receiver ranges and positions to solve an extra clock offset is unknown[2]. As a result, the GPS receiver delivers uninterrupted navigation information at a low cost, but it may lose satellite navigation information owing to a barrier or signal jamming[3].

Inertial navigation devices are widely used in contemporary military equipment such as aircraft and cruise missiles. For example, the cruise missile's extremely high accuracies in recent wars are a direct consequence of the use of advanced navigation techniques [4]. An onboard inertial measuring unit (IMU), a CPU (processor), and integrated navigation software comprise an inertial, navigation system (INS), with the IMU's components including inertial sensors (accelerometers and gyros) and the related electronics and hardware. The location solution is achieved via numerically calculating Newton's motion equations based on vehicle-specific forces and rotation speeds acquired from onboard inertial sensors (IS) [5].

For two reasons, GPS and inertial measurements are complimentary. First, they have various error characteristics and measure various amounts. The Global Positioning System (GPS) delivers location and velocity data. An accelerometer is a device that measures force [6].

In comparison to either a GPS or an INS stand-alone system, integrating the global positioning system (GPS) and inertial navigation system (INS) is a crucial way of maintaining dependable navigation capacity [7].

Because of their complementing characteristics, the INS/GPS combination improves reliability, latency, bandwidth, and update rate as compared to the GPS-only solution [8]. In addition, INS/GPS integration systems have been extensively used for aircraft autonomous landing and approach, Navigation and tracking of land vehicles, marine applications, and aviation surveys, among other things [9]. To achieve the integration process between GPS and INS, there should be a prediction method that synchronizes between GPS and INS and also predicts cutoff values from GPS signals. Gaussian Process (GP) method is chosen in this work to predict the instant of GPS data because of its advantages in noisy, distorted, or erroneous data according to other predictor methods. It then makes GPS/INS integration.

In previous years, many predictors have been used as advanced artificial intelligence (AI) technology to minimize GPS signal loss. Some studies have used an AI-assisted Kalman filter (KF) for INS/GPS integration. When the GPS signal is disrupted, the most frequent technique is to fix the inertial navigation system and estimate the inaccuracy using (AI) rather than the Kalman filter. Fuzzy logic and neural networks are two examples of artificial intelligence approaches widely employed to increase system performance. In reference [10], an adaptive fuzzy logic technique was presented that controlled the development of an INS error model to minimize inertial navigation error divergence. An extreme learning machine (ELM) based on Fourier orthogonal basis functions is suggested, considering the degradation of navigation system accuracy under GPS blocking. It offers higher positioning precision and a faster learning speed than the traditional neural network (NN) learning method [4]. The authors of [5, 11] proposed a prediction technique based on a Radial Basis Function neural network (RBF) linked with time-series analysis to anticipate the KF technique's measurement update. In [5], for example, when GPS problems happen, the RBF neural network outputs are utilized directly to adjust the INS findings. The RBF is used to forecast GPS/SINS KF measurements to ensure that the filter in the system operates normally during GPS interruptions [11]. Another method is when the GPS is blocked. The hybrid system may forecast and calculate a pseudo-GPS position [12]. As for the methods of integration INS/GPS, many methods exist even when the GPS is interrupted, including a Kalman filter is the most popular method to use [8]. The Wavelet-Neural Network (WNN) was used to integrate the INS/GPS signals, which may give the exact position of the vehicles during GPS failures [13]. When GPS is unavailable, (MDF CKF) coupled with an RF-based dual model is utilized to correct for positioning and velocity errors in GPS/INS integration [7]. The Street Return Algorithm (SRA) is a novel integrated technique for integrating or embedding into INS/GPS integration systems to improve accuracy, reduce the size, and keep costs low [14]. The integration technique, INS, and GPS can be connected in various ways. The integration complexity and the sensors' and GPS receivers' needs differ. Coupling techniques are classified into two types: tightly coupled filters and loosely coupled filters [15]. Because the GPS gives data every 1 second, while the INS gives every 0.1 seconds, hence synchronization between data must be applied. So, the first step is to use the Gaussian algorithm to fulfill this condition, and the second step is to make an integration of GPS/INS.

A Gaussian process (GP) is a stochastic process (a set of random variables) with a joint Gaussian distribution for every finite collection of random variables. A GP model's predictions are smoothed access to the original data [16, 17]. Stochastic variation inference can manage enormous amounts of data that would otherwise be hard to process with traditional GP learning approaches [18]. This work took a path from a boat consisting of GPS and INS data. Initially, a prediction algorithm was proposed to process the rate of difference of data from both systems and predict the GPS signal losses, which is the GP algorithm. After that, the INS errors are addressed and reduced by using and applying the extended Kalman filter to two types of INS/GPS integration systems.

2. Experimental work

2.1 Data Generation

In this work, the GPS type is (A u-blox module with a compass, and the main reason for using this type is because, first, it is very sophisticated and contains an integrated antenna in addition to its lightweight of (32g). Secondly, it has good electronic properties, including an Anti-interference design), can be heavy-duty, low noise regulator was used to processing the readings. INS sensor was connected to a boat. The readings were taken using the Mission Planner program as in Figure 1 and processed using the MATLAB program to obtain the required results.

2.2 Gaussian Process (GP)

The Gaussian process is a stochastic process that may be found in various study disciplines, including data transmission, networks, and computing science. It is frequently utilized as a non-parametric and probabilistic technique for modeling the target systems' properties. As opposed to generating the model's parameters from the start, the Gaussian process assists in adapting these parameters should be used to indicate the actual underlying function. As a result, the GP is a good substitute for noisy environments, erroneous data, or distorted. In reality, several applications use the (GP), including image classification, dimensional reduction, unsupervised learning issues, and time series prediction [19]. Due to its resilience and dynamic characteristics, the Gaussian process has grown in popularity over the last ten years for modelling a wide range of conclusions and reasoning solutions [20].



Figure 1: Boat Tracking, a- mission planner, b- boat

2.2.1 Prediction with Gaussian process model

The objective of prediction is to forecast GPS receiver readings even when blocking them for a short period. The inference technique and probability framework used in this work are Gaussian process regression and Bayesian learning. Because this model's input data is time series, curve fit is recommended over mapping functions for the mapping technique. It is imperative to realize that the curves' fit is more adaptable than time-series and the non-stationary type. Considering that the input data is a restricted set of time locations $x = [x_1, x_2, x_3, \dots, x_n]$, a finite set of random variables $y = [y_1, y_2, y_3, \dots, y_n]$ reflects the appropriate joint Gaussian distribution of incoming processes in terms of time order [20,21]. It involves estimating:

$$ff(x) \sim \mathcal{GP}(m(x), k(x, x')) \tag{1}$$

With

$$m(x) = E(f(x)) \tag{2}$$

Where $x \in \mathbf{R}^{\mathcal{A} \times 1}$ denote the input vector, f represents the regression function with a training set of n observations $\mathcal{A} = (x_i, y_i) (1 \leq i \leq n)$. In this essay, use shorthand notation to combine all of the input vectors x_i into a matrix $X \in \mathbf{R}^{n \times \mathcal{A}}$ and all of the associated output vectors " y_i " into a vector $y \in \mathbf{R}^{n \times 1}$. As a result, the training set may be represented as (X, y) .

From the standard regression function (i.e., Eq. 3):

$$[Y = f(x) + \varepsilon] \tag{3}$$

It can be seen that;

$$y \sim \mathcal{N}(m(X), K + \sigma^2 I) \tag{4}$$

Where y ; denote the observed value, $\varepsilon \sim \mathcal{N}(0, \sigma_e^2)$: denotes the number of observations.

\mathcal{N} : Denote distributed Gaussian noise.

I : Is identity matrix.

$m(X)$: is the mean.

σ : is the covariance

Gaussian noise with independent, symmetric distribution. $K = k(X, X') \in \mathbf{R}^{n \times n}$. On the test points, both the observable data y and the latent noise-free function are distributed. $f_{\bullet} = f(X_{\bullet})$ is defined in this situation by:

$$\begin{bmatrix} y \\ f_{\bullet} \end{bmatrix} \sim \mathcal{N} \left(\begin{bmatrix} m(X) \\ m(X_{\bullet}) \end{bmatrix}, \begin{bmatrix} K + \sigma^2 I & K_{\bullet} \\ K_{\bullet}^T & K_{\bullet\bullet} \end{bmatrix} \right) \tag{5}$$

Where $K_{\bullet} = k(X, X_{\bullet}) \in \mathbf{R}^{n \times n_{\bullet}}$, and $K_{\bullet\bullet} = k(X_{\bullet}, X_{\bullet}) \in \mathbf{R}^{n_{\bullet} \times n_{\bullet}}$

It is also possible to show that Gaussian is the posterior predictive density.

$$f_{\bullet} | X, Y, X_{\bullet} \sim \mathcal{N}(m_{\bullet}, \sigma_{\bullet}^2) \tag{6}$$

Where m_{\bullet} , σ_{\bullet}^2 the mean and covariance in Eq. (7) and (8)

$$m_{\bullet} = m(x_{\bullet}) + K^T (K + \sigma_{\xi}^2 I)^{-1} (y - m(x)) \tag{7}$$

$$\sigma_{\bullet}^2 = K_{\bullet\bullet} - K^T (K + \sigma_{\xi}^2 I)^{-1} K \tag{8}$$

Take a look at what accurse when there is only one test point x_{\bullet} . Where K. is the covariance vector between the testing and "n" training points.

$$K_{\bullet} = [k(x_{\bullet}, x_1) \dots k(x_{\bullet}, x_n)] \tag{9}$$

So, the equation (7) will be:

$$m_{\bullet} = m(x_{\bullet}) + k^T (K + \sigma_{\xi}^2 I)^{-1} (y - m(x_{\bullet})) \tag{10}$$

2.3 INS/GPS Integration

GPS has the benefits of being weatherproof, global, and reliably precise. However, a GPS receiver's data update rate is usually low at (1 Hz), and its output is proportional to the number of satellites monitored. INS is one of the most often used dead reckoning techniques. It can provide a periodic location, velocity, and orientation estimations that are accurate in the short term but susceptible to drift due to sensor drift [22]. As a result of the benefits and drawbacks of INS and GPS, they can be combined to produce an INS/GPS integration system. This integration system can potentially improve positioning performance by combining the advantages of different systems such as GPS, which allows the correction of inertial sensor biases, and the INS, which may be utilized to increase the navigation and re-acquisition performance of the GPS receiver [23].

For several years, Kalman filtering (KF) was used to produce an optimum GPS/INS integrated module [9]. In this paper, an Extended-Kalman-Filter (EKF) is utilized since it is extensively used in land navigation for integrated systems that function well in most scenarios [24, 25].

2.3.1 Loosely coupled integration

The INS/GPS navigation system may overcome the drawbacks of each navigation technology and enhance overall system performance. The block diagram of the loosely coupled INS/GPS integration system is illustrated in Figure 2 [4].

In this integration system, a navigation processor inside that GPS receiver calculates the position (PGPS) and velocity (VGPS) using just GPS observables. An external navigation filter computes position (PINS), velocity (VINS), and attitude (AINS) from basic inertial sensor readings and uses GPS location and velocity to rectify INS errors. The GPS receiver can be considered a black box in a loosely connected system, which is a benefit. The blended navigation filter will be easier if GPS preprocessed location and velocity information are used. In the case of a GPS failure, the GPS ceases sending processed information [14]. The state equation and measurement equation may be written using the integrated system with loosely coupling depending on the Kalman filter [4,12] as:

$$\begin{aligned} \dot{X} &= FX + GW \\ Z &= HX + V \end{aligned} \tag{11}$$

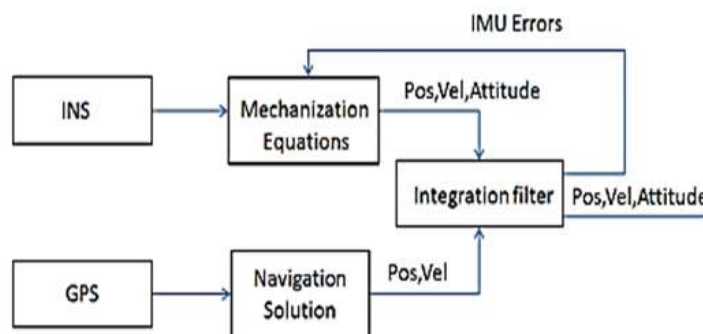

Figure 2: Loosely coupled for integration of INS/GPS.

X represents the state variables, F represents the system matrices, G represents the system distortion matrix, and W represents the process noise vector. The observation matrix is H , and the observing vector is Z . The observation noise vector is denoted by the letter V . The observation vector Z represents the difference in INS and GPS locations. The states vector X is configured as eq. (11):

$$X = [\phi_E \ \phi_N \ \phi_U \ \delta V_E \ \delta V_N \ \delta V_U \ \delta L \ \delta \lambda \ \delta h \ \nabla_x \ \nabla_y \ \nabla_z \ \varepsilon_x \ \varepsilon_y \ \varepsilon_z]^T \tag{12}$$

Where $(\phi_E \ \phi_N \ \phi_U)$ are (Attitude error) of the estimated platform in local coordinate frame g , $(\delta V_E \ \delta V_N \ \delta V_U)$, are three-axis velocity errors of frame g , $(\delta L, \delta \lambda, \text{ and } \delta h)$ signify location errors, $(\nabla_x \ \nabla_y \ \nabla_z)$ and $(\varepsilon_x \ \varepsilon_y \ \varepsilon_z)$ denote accelerometer and gyros biases in three axes of the body frame b , respectively. In this study, in the loosely connected GPS/INS integrated system, a 3-dimensional measurement vector was created. This is the three-dimensional location difference between INS, and GPS Eq. (13) may be used to calculate the measurement vector Z :

$$Z = [P_{INS} - P_{GPS}] \tag{13}$$

The following are the disadvantages of the loosely connected integration structure [26]:

- It is immune to GPS location and velocity outputs. There is no assistance to the INS if GPS is not calculating output.
- It cannot identify jamming on GPS signals because the filter only functions on GPS navigation outputs; and
- It cannot assist GPS in tracking satellites since there is no feedback to GPS.

The advantage of the loosely connected arrangement is that it is extremely modular in terms of accuracy and cost, as well as simplicity of development because it is simpler.

2.3.2 Tightly coupled integration

Tightly-coupled integration uses an approximated technique to integrate inertial sensor readings with GPS data to compute the vehicle's location, velocity, and orientation, as shown in Figure 3 [27].

Using error states or total states in INS/GPS tightly-coupled integration results in similar system estimate accuracy for the EKF [28]. In a highly connected GPS/INS system, GPS pseudo-range and delta range measurements are handled in the data fusion process to calibrate the IMU and avoid the development of navigation errors caused by an unassisted INS. The direct processing of raw GPS signals has numerous benefits over the loosely linked technique that uses GPS location and velocity information. The most obvious advantage is that when fewer than four satellites are in view. The INS can still assist the remaining satellites using the information included in the pseudo-range and delta range data. Still, in a loosely connected system, the INS remains unaided under similar situations [29]. The benefits of the tightly coupled integration structure are as follows [26]:

- It is more robust and improves system integrity;
- It outperforms loosely coupled integration in terms of performance; and
- It has a greater ability to reject jamming signals.
- Because raw data (pseudo and delta-range) are employed, INS can only be assisted by one satellite. Therefore, GPS does not require providing navigation outputs.
- GPS tracking loops are helped by feedback to the GPS receiver.

Tightly linked integration has the disadvantage of being more expensive to deploy and more complex to evolve.

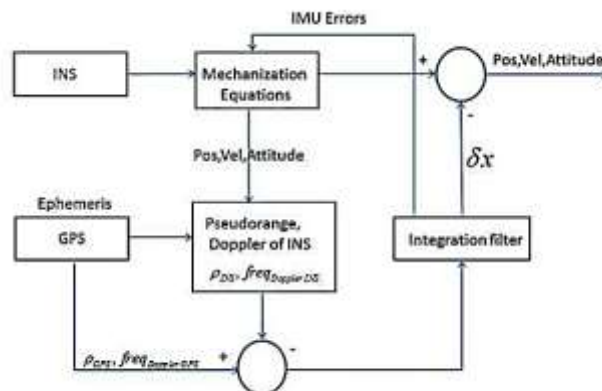

Figure 3: tightly coupled INS/GPS integration

2.3.3 Extended Kalman filter

): The Kalman filter technique is frequently utilized in inertial navigation systems. Because of the underlying state-space model, it has a lot of leeways, for example, to incorporate more differential equations or deal with data updates from multiple sensors. Researchers discovered that the navigation formulas are non-linear systems [15]. Because the low-cost inertial sensors employed have comparatively poor performance, it is decided to apply EKF, in which nonlinear systems are linearized about the predicted trajectory to improve performance. This is accomplished using a closed-loop (feedback) version of INS/GPS integration. EKF theory is widely established, and further information can be found in [24]. Two vectors of states the navigation system outputs are stored in z_k : location, velocity, and attitude. a_k . On the other hand, it includes the inputs to the navigation system: accelerations and angular rates [15]. These two parameters are denoted by:

$$z_k = h [r_k^{eT} v_k^{eT} \theta_k^T]^T \tag{13}$$

$$a_k = h [f_k^{bT} \omega_{ib,k}^{bT}]^T \tag{14}$$

The state vectors z_k and a_k can be estimated as follows in Eq. (15):

$$\hat{a}_k = \bar{a}_k + \delta \hat{a}_k \tag{16}$$

Where ($\hat{\cdot}$) means estimated states and ($\bar{\cdot}$) forecast states. The Forecast of the covariance according to the model, P_{k+1}^- is propagated.

$$P_{k+1}^- = \Phi_k P_k^- \Phi_k^T + Q_{d,k}, \tag{17}$$

With Φ_k defined in Eq.18 and $Q_{d,k}$ defined in Eq.19

$$\Phi_k \approx I + F(kT_s)T_s \tag{18}$$

$$Q_{d,k} \approx \text{diag}(0_3, \sigma_{acc}^2 I_3, \sigma_{gyro}^2 I_3, 0_6) \tag{19}$$

Where $\text{diag}(\cdot)$ denotes a block diagonal matrix. $F(t)$ varying matrices and T_s is the integration time. Figure 4 illustrates the algorithm of the extended Kalman filter.

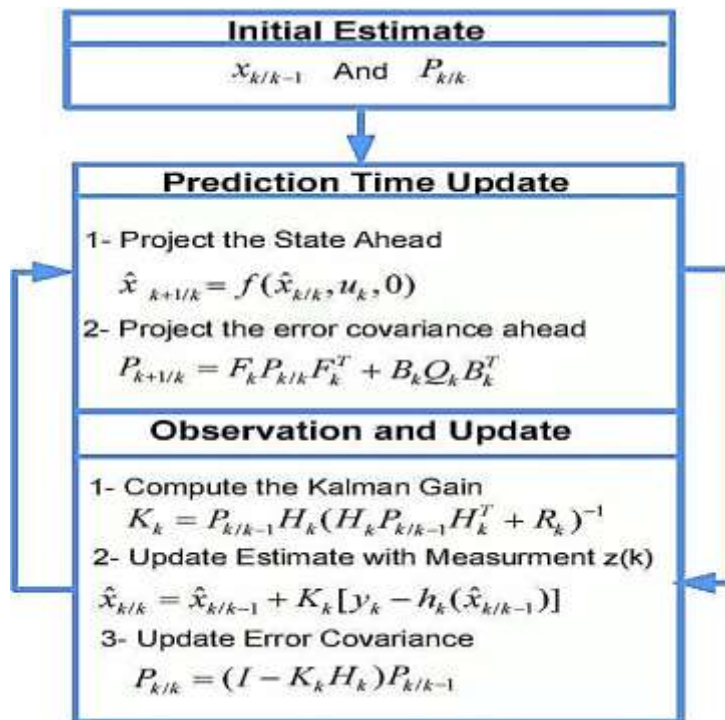

Figure 4: Algorithm of Extended Kalman Filter

3. Experimental Results

To achieve the best prediction when the GPS data were missed for some time, the GP algorithm was proposed and implemented as a predictor of the GPS losses signals. Moreover, this helps to achieve synchronization between the GPS receiver signals and the INS signals for INS/GPS integration. In this work, one blocking period was taken for 9 seconds, and then the reaction of the prediction algorithm was observed.

To measure the approaches quality, the Root Main Square Error (RMSE) is calculated from the following Equation [30]:

$$RMSE = \sqrt{\frac{1}{n} \sum_{i=1}^n e_i^2} \tag{20}$$

Where $e_i = X_i - x_i$

X_i ; The predicted data of GPS receiver, and x_i is the reference or (original) of GPS data.

Figures 5 a1, b1, and c1, illustrate the missing GPS receiver for real data. This blocking lasted for (9 seconds) on all (X, Y, and Z-axis). The presence of this cut was imposed (that is, part of the path data was cut). In addition, as mentioned above, the GPS signal can get jammed or cut off. The reaction of the prediction algorithm with the required results is shown in Figures 5 a2, b2, and c2. The resultant RMSE, standard deviation, and variance of GPS data receiver in (the X-axis, Y-axis, and Z-axis) can be seen in Table 1.

Table 1: The result of RMSE, standard deviation, and variance of GPS data receiver in (X-axis, Y-axis, and Z-axis)

Parameters	9sec outage X-Axis	9sec outage Y-Axis	9sec outage Z-Axis
RMSE max	213.7624	296.8840	0.4549
RMSE min	0.00004754	0.00603	0.00003799
Standard Deviation	26.106	40.6521	0.05164
Variance	681.5232	1652.5932	0.0026666

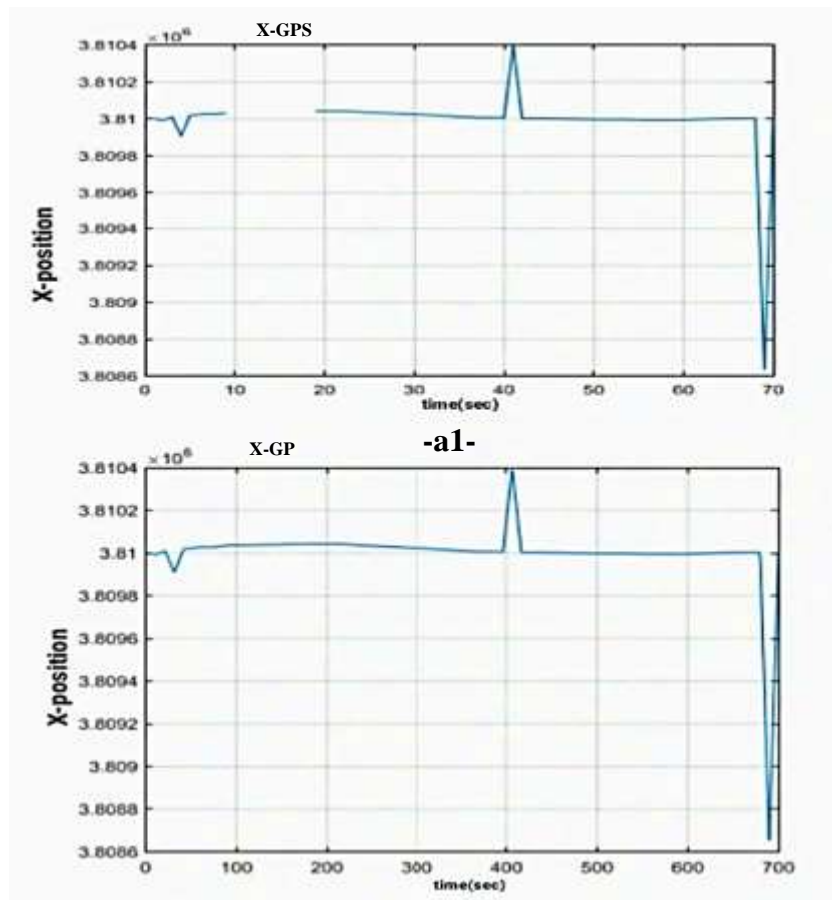

Figure 5: Continued

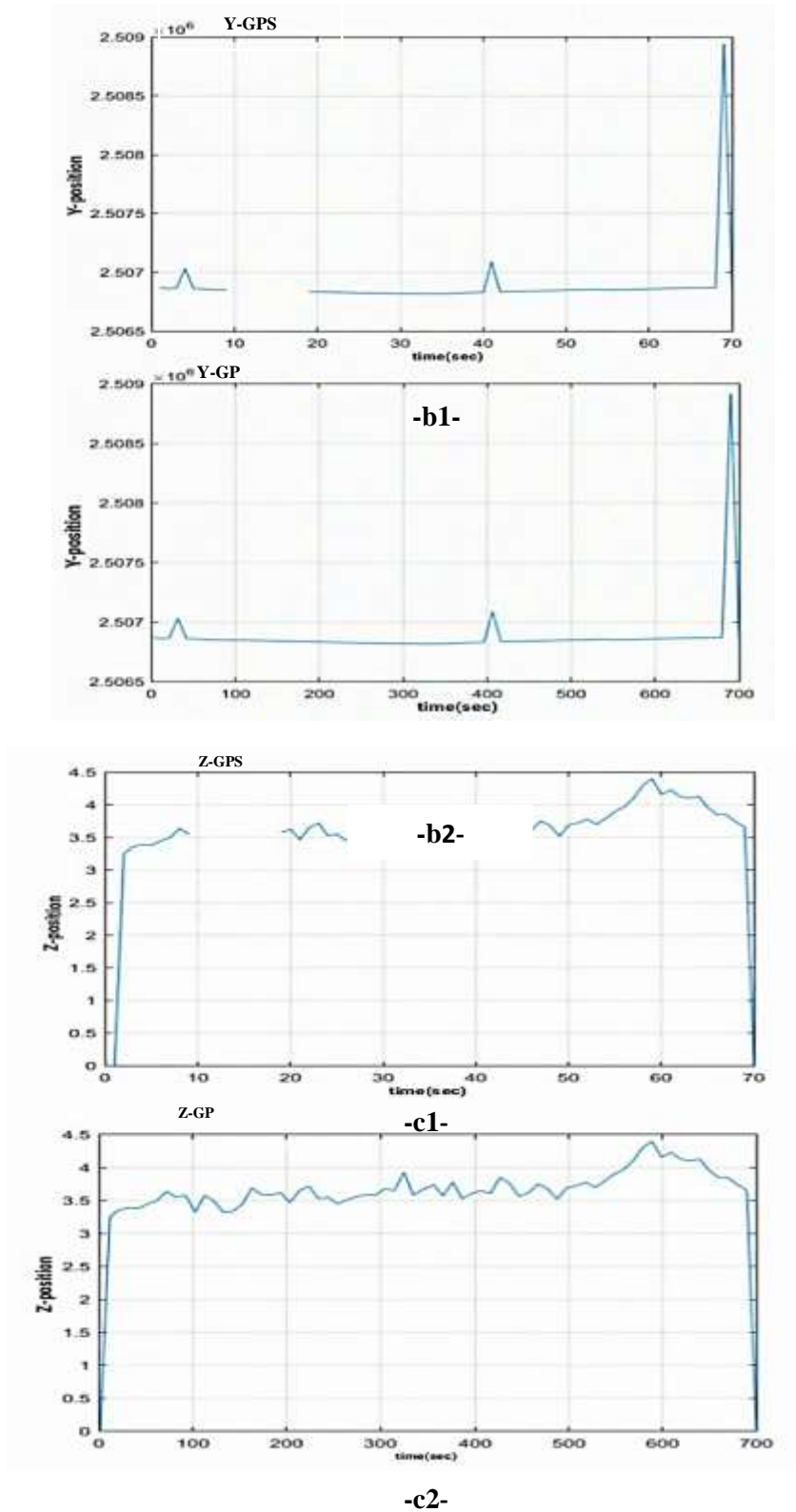

Figure 5: GPS data after 9-second blocking in (x axis, y axis, and z axis) and the results of output prediction algorithm in (X-axis, Y-axis, and Z-axis)

The algorithm results in a good level of accuracy. It produces low values of RMS error, variance, and standard deviation. Compared to previous works, it has a great approximation ability, suitability, and high effect for accurate positioning to predict GPS data. It also reduces MSE less than in the previous studies we have conducted using the NARX algorithm; the RMS ranged between (0.00005 m - 223.733m) in X-axis positioning, (0.00593 m- 291.732m) in Y-axis positioning, and (0.0000376 m – 0.45043m) in Z-axis positioning. Also, for previous studies, the researcher in the source [31] used (RBF and WNN)

algorithms, and from the results they obtained, we have seen It is the amount of error in the x-axis ranges between (0.000415 – 7.8878e-05), while in the Y-axis the error ranges between (0.14187 – 4.7282e-05) and the Z-axis was the error between (0.585108 -3.0780 e-05). As for the results obtained from the GP algorithm used in this work, as shown in the above table, the least error ranges between (0.00004754 - 213.7624). Thus, the GP algorithm is better than the previously used one in predicting GPS signals.

This work uses two integration approaches: the loosely and the tightly coupled systems. The loosely linked system normally is the common approach that is utilized in this work to accomplish the integration of INS and GPS systems. However, because of its simplicity, this technique was chosen; the GPS receiver outputs are directly applicable to the INS outputs.

The integration process employing loosely linked INS/GPS with EKF in three-axis (X, Y, and Z) minimizes the INS errors and correct them according to GPS data. The more precise GPS data prediction (obtained using the GP prediction method) is employed, as shown in Figures 6 & 7, where the blue color curve is the INS, and the red color is the GPS. In contrast, the green color curve represents the integration between GPS and INS that can reduce the INS error. It is closer to the GPS curve, and this is what must be obtained from the integration.

Figure 6 illustrates the loosely integration method between GPS and INS values. Figure 6 (a) shows the loosely method results on the X-axis axis, while Figure 6 (b) shows the effect of integration on the y-axis. Finally, Figure 6 (c) shows the effect of integration on the values on the z-axis.

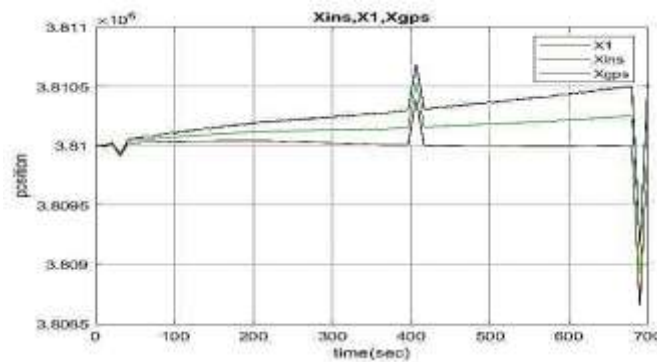

-a-

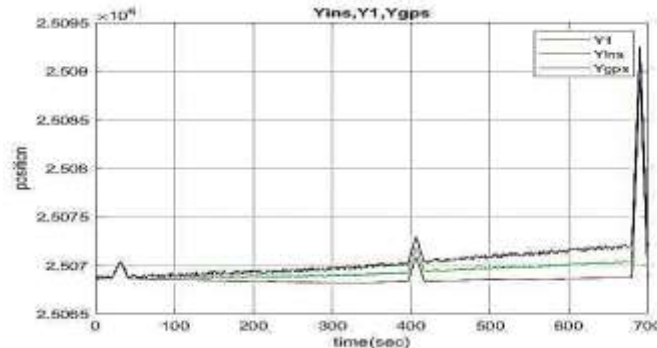

-b-

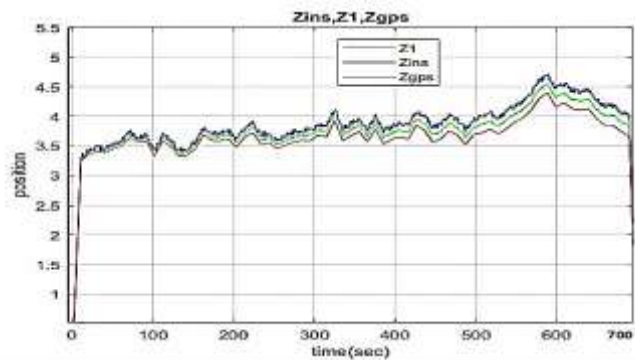

-c-

Figure 6: INS/GPS integration is loosely coupled in (a) X-axis, (b) Y-axis, and (c) Z-axis

The second technique utilized in this study to integrate INS and GPS systems is a tightly coupled method. This technique has several advances. First, it can handle massive processing amounts of data and gives a single point of truth (the optimum point) rather than multiple or sometimes redundant points, better debugging of INS system with good data resources.

Figure 7 illustrates the INS/GPS integration results in the three coordinates (X, Y, and Z). As shown, the integrated curves converge tightly to the GPS curve and try to minimize the error. Therefore, the tightly type in the INS/GPS integration is slightly better than the loose type. Figure 7 shows the Tightly integration method between GPS and INS. Figures 7 (a) illustrates the Tight Couple integration method results on the X-axis axis, while Figure 7 (b) shows the effect of the Tight Couple integration on the y-axis. Finally, Figure 7 (c) shows the effect of the Tight Couple integration on the values on the z-axis.

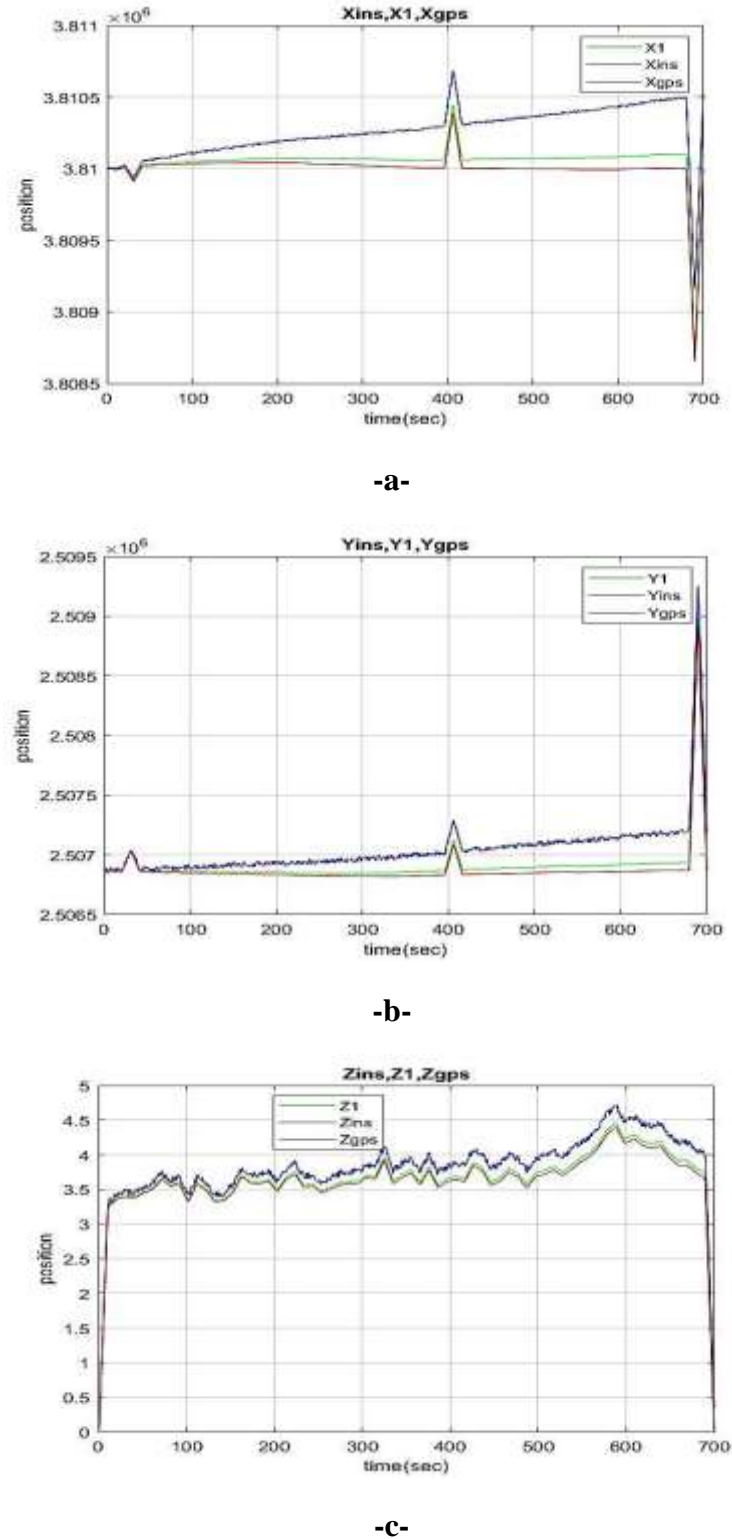

Figure 7: INS/GPS integration in tightly coupled in: (a) X-axis, (b) Y-axis and (c) Z-axis

Table 2: (a, b, c); The result of RMSE, the standard deviation of INS data before and after integration in (a: X-axis, b: Y-axis, and c: Z-axis)

Parameters	INS before integrated X-Axis	INS/GPS integrated (loosely) X-Axis	INS/GPS Integrated (tightly) X-Axis
RMSE max	22.8235	20.4140	16.1387
RMSE min	1.0757	0.9622	0.7607
Standard deviation	147.9039	118.3231	73.9519

-a-

Parameters	INS before integrated Y-Axis	INS/GPS Integrated (loosely)Y-Axis	INS/GPS Integrated (tightly) Y-Axis
RMSE max	18.7398	16.7614	13.2510
RMSE min	0.7426	0.6642	0.5251
Standard deviation	97.9519	78.3615	48.9759

-b-

Parameters	INS before integrated Z-Axis	INS /GPS integrated (loosely) Z-Axis	INS/GPS Integrated(tightly) Z-Axis
RMSE max	0.6147	0.5498	0.4347
RMSE min	0.0813	0.0727	0.0575
Standard deviation	0.0903	0.0723	0.0451

-c-

Every 0.1 second, GPS results and INS reading values are used to estimate the INS system's error. The estimated error is subtracted from the INS measurement to obtain the corrected INS measurement. So, it can be seen that the blue curve, which is the INS data has some ripple response due to its error along the curve, as shown in Figures 6 and 7. This is due to INS errors. The red curve does not exist; this is the GPS, where errors are few. As for the green curve, this is as explained above. It represents the integration between the two systems, and it is closer to the GPS curve, the better (meaning that a very small amount of error was reached). As a summary of Figure 6 and 7 responses and to deal with the unreliability of INS sensors and their divergence during operation, two types of combined INS/GPS systems are used. The performance of integrated INS/GPS systems is compared with and without GPS data blocking. The results reveal that, compared to a stand-alone INS system, the position error (in the three coordinates (X, Y, Z) is minimal. Also, combining an INS/GPS navigation system utilizing a tightly linked system is the best option. Table 2 compares the loosely and tightly integrated method in the two systems (INS and the GPS) in the three axes.

Tables 2a, b, and c show that the INS average error before the integration was (22.8235). Still, after integrating GPS and using EKF, this error became (20.4140) in loose integration and (16.1387) in tight integration for the X-axis. As for the rest of the axes, the INS errors were corrected according to the GPS signal, as shown in the tables. As a result, it can be proved that the tightly EKF approach is a good approach that can be used for the INS/GPS integration purpose.

4. Conclusion and Future Works

GPS technology has become widely applied in real navigation applications and services. Occasionally, it must be integrated with the inertial navigation system (INS) device. Therefore, two approaches were developed for integration purposes: loosely and tightly.

The following are some conclusions that were reached along with this project:

- 1) The Gaussian technique (GP) was introduced to predict missing GPS data between sampling instants when they are interrupted for some time.
- 2) From the result above, one can see that the interruption period of 9 seconds for three axes (x, y, and z) where the algorithm has an effective operation for predicting. Furthermore, the result can be shown in Table 1, which indicates the error (RMS min) when the interruption occurred for 9 seconds, as well as the standard deviation and variance; in other words, the amount of the error remains small.
- 3) Figures 6 and 7 and Table 2 show that the tightly coupled INS/GPS integration method is the best for correcting INS errors.
- 4) From the above results, one can use a low-cost INS system and get the high-cost INS system performance by applying the low-cost INS system with the tightly coupled INS/GPS integration method.

In future work, other methods can be used to predict the discontinuous GPS data, such as the genetic algorithm. Additionally, another integration method can be investigated using the capture Kalman filter (CKF) and comparing it with the current work.

Author contribution

All authors contributed equally to this work.

Funding

This research received no specific grant from any funding agency in the public, commercial, or not-for-profit sectors.

Data availability statement

The data that support the findings of this study are available on request from the corresponding author.

Conflicts of interest

The authors declare that there is no conflict of interest.

References

- [1] B. Rahmatullah, A. A. Zaidan, F. Mohamed, and A. Sali, Multi-complex attributes analysis for optimum GPS baseband receiver tracking channels selection, In 2017 4th international conference on control, decision and information technologies (CoDIT) (pp. 1084-1088). IEEE.,(2017). doi : 10.1109/CoDIT.2017.8102743
- [2] M. Advani, and D. S. Weile, Position and orientation inference via on-board triangulation, Plos one., 12 (2017) e0180089. doi.org/10.1371/journal.pone.0180089
- [3] R., Sabatini, T., Moore, and S. Ramasamy, Global navigation satellite systems performance analysis and augmentation strategies in aviation, Progress in Aerospace Sciences., 95 (2017) 45-98. doi.org/10.1016/j.paerosci.2017.10.002
- [4] D. Wang, X. Xu, and Y. Zhu, A novel hybrid of a fading filter and an extreme learning machine for GPS/INS during GPS outages, Sensors., 18 (2018) 3863. doi.org/10.3390/s18113863
- [5] L. Chen, and F. Jiancheng, A hybrid prediction method for bridging GPS outages in high-precision POS application. IEEE Transactions on Instrumentation and Measurement., 63 (2014) 1656-1665. <https://doi.org/10.1109/TIM.2013.2292277>
- [6] G. T. Schmidt, and R. E. Phillips, INS/GPS Integration Architectures, Massachusetts Inst of Tech, Lexington, MA. RTO-EN-SET-116., (2010). <https://apps.dtic.mil/sti/pdfs/ADA581020.pdf>
- [7] Y. Zhang, C. Shen, J. Tang, and J. Liu, Hybrid algorithm based on MDF-CKF and RF for GPS/INS system during GPS outages, IEEE Access., 6 (2018) 35343-35354. <https://doi.org/10.1109/ACCESS.2018.2849217>
- [8] Y. Tang, Y. Wu, M. Wu, W. Wu, X. Hu, and L. Shen, INS/GPS integration: Global observability analysis, IEEE Transactions on Vehicular Technology., 58 (2008) 1129-1142. <https://doi.org/10.1109/TVT.2008.926213>
- [9] A. Noureldin, A. El-Shafie, and M. Bayoumi, "GPS/INS integration utilizing dynamic neural networks for vehicular navigation," Information fusion., 12(2011) 48-57. <https://doi.org/10.1016/j.inffus.2010.01.003>
- [10] C. H. Tseng, S. F. Lin, D.J. Jwo, Fuzzy adaptive cubature Kalman filter for integrated navigation systems, Sensors., 16 (2016) 1167. <https://doi.org/10.3390/s16081167>
- [11] X. C. Tian, and C. D. Xu, Novel hybrid of strong tracking Kalman filter and improved radial basis function neural network for GPS/INS integrated navigation, In 2016 2nd International Conference on Control Science and Systems Engineering (ICCSSE), IEEE., (2016) 72-76. <https://doi.org/10.1109/CCSSE.2016.7784356>
- [12] Y. Yao, X. Xu, C. Zhu, and C. Y. Chan, A hybrid fusion algorithm for GPS/INS integration during GPS outages, Measurement., 103 (2017) 42-51. <https://doi.org/10.1016/j.measurement.2017.01.053>
- [13] X. Chen, C. Shen, W. B. Zhang, M. Tomizuka, Y. Xu, and K. Chiu, Novel hybrid of strong tracking Kalman filter and wavelet neural network for GPS/INS during GPS outages, Measurement., 46 (2013) 3847-3854. <https://doi.org/10.1016/j.measurement.2013.07.016>
- [14] N. Q. Vinh, INS/GPS integration system using street return algorithm and compass sensor, Procedia Computer Science., 103 (2017) 475-482. <https://doi.org/10.1016/j.procs.2017.01.030>
- [15] A. Schumacher, Integration of a gps aided strapdown inertial navigation system for land vehicles, Master of Science Thesis, KTH Electrical Engineering., (2006).
- [16] C. K. Arthur, V. A. Temeng, and Y. Y. Ziggah, Novel approach to predicting blast-induced ground vibration using Gaussian process regression, Engineering with Computers., 36 (2020) 29-42. <https://doi.org/10.1007/s00366-018-0686-3>

- [17] H. S. Jo, C. Park, E. Lee, H. K. Choi, and J. Park, Path loss prediction based on machine learning techniques: Principal component analysis, artificial neural network, and Gaussian process, *Sensors.*, 20 (2020) 1927. <https://doi.org/10.3390/s20071927>
- [18] R. Senanayake, S. O'Callaghan, and F. Ramos, Predicting spatio-temporal propagation of seasonal influenza using variational Gaussian process regression, In *Proceedings of the AAI Conference on Artificial Intelligence.*, 30 (2016). <https://doi.org/10.1609/aaai.v30i1.9899>
- [19] D. M. Bui, H. Q. Nguyen, Y. Yoon, S. Jun, M. B. Amin, and S. Lee, Gaussian process for predicting CPU utilization and its application to energy efficiency, *Applied Intelligence.*, 43 (2015) 874-891. <https://doi.org/10.1007/s10489-015-0688-4>
- [20] Titsias, K. Michalis and N. D. Lawrence. Gaussian process latent variable models for visualisation of high dimensional data. *Adv. in Neural Inf. Proc. Sys.*, (2004). <https://proceedings.neurips.cc/paper/2003/file/9657c1fffd38824e5ab0472e022e577e-Paper.pdf>
- [21] H. Tolba, N. Dkhili, J. Nou, J. Eynard, S. Thil, and S. Grieu, GHI forecasting using Gaussian process regression, In *IFAC Workshop on Control of Smart Grid and Renewable Energy Systems.*, (2019). <https://hal.archives-ouvertes.fr/hal-02051993>
- [22] W. Wang, Z. Y. Liu, and R. R. Xie, Quadratic extended Kalman filter approach for GPS/INS integration, *Aerospace science and technology.*, 10 (2006) 709-713. <https://doi.org/10.1016/j.ast.2006.03.003>
- [23] N. Q. Vinh, INS/GPS integration system using street return algorithm and compass sensor, *Procedia Computer Science*, 103 (2017) 475-482. <https://doi.org/10.1016/j.procs.2017.01.030>
- [24] A. Noureldin, T. B. Karamat, M. D. Eberts, and A. El-Shafie, Performance enhancement of MEMS-based INS/GPS integration for low-cost navigation applications. *IEEE Transactions on vehicular technology.*, 58 (2008) 1077-1096. doi: 10.1109/TVT.2008.926076
- [25] M. St-Pierre, and D. Gingras, Comparison between the unscented Kalman filter and the extended Kalman filter for the position estimation module of an integrated navigation information system, In *IEEE Intelligent Vehicles Symposium IEEE.*, (2004) 831-835. doi: 10.1109/IVS.2004.1336492
- [26] Öztürk, A. (2003). Development, implementation, and testing of a tightly coupled integrated INS/GPS system (Doctoral dissertation, METU). <https://etd.lib.metu.edu.tr/upload/4/1093087/index.pdf>
- [27] M. Wang, W. Wu, P. Zhou, and X. He, State transformation extended Kalman filter for GPS/SINS tightly coupled integration, *Gps Solutions.*, 22 (2018) 1-12. <https://doi.org/10.1007/s10291-018-0773-3>
- [28] J. Zhou, S. Knedlik, and O. Loffeld, INS/GPS tightly-coupled integration using adaptive unscented particle filter, *The Journal of Navigation.*, 63 (2010) 491-511. <https://doi.org/10.1017/S0373463310000068>
- [29] Y. Li, J. Wang, and C. Rizos, Comparison of the extended and sigma-point kalman filters on inertial sensor bias estimation through tight integration of GPS and INS, In *Proceedings of the 19th International Technical Meeting of the Satellite Division of The Institute of Navigation ION GNSS.*, (2006) 1625-1634.
- [30] T. Chai, and R. R. Draxler, Root mean square error (RMSE) or mean absolute error (MAE), *Geoscientific Model Development Discussions.*, 7 (2014) 1525-1534. <https://doi.org/10.5194/gmd-7-1247-2014>
- [31] H. N. AbdulRihda, F. M. Mohammed, S. A. Aziez, Integration of (INS/DGPS) System For Airplane Landing Phase, Msc. Thesis, university of technology, Iraq., (2015). <https://ieeauthorcenter.ieee.org/wp-content/uploads/IEEE-Reference-Guide.pdf>