



## Experimental and Theoretical Analysis to Produce Pentagonal Cup in Deep Drawing Process



Zainab H. Mohsein\* , Waleed K. Jawad, Aseel H. Abed 

Production Engineering and Metallurgy Dept., University of Technology-Iraq, Alsina'a street, 10066 Baghdad, Iraq.

\*Corresponding author Email: [Zainab.H.Mehsen@uotechnology.edu.iq](mailto:Zainab.H.Mehsen@uotechnology.edu.iq)

### HIGHLIGHTS

- Pentagonal cups were fabricated using two forming methods.
- The second forming method is the best method to produce a pentagonal cup.
- Complex shapes in the deep drawing process can be produced using the second forming method.

### ABSTRACT

The manufacturing industry heavily relies on deep drawing due to its remarkable ability to produce intricate symmetrical and asymmetrical shapes with accuracy and efficiency. This research aimed to create a deep drawing tool capable of producing a pentagonal cup measuring 41mm in diameter and 30mm in height. This was achieved by conducting numerical simulations and experimental tests using two different methods. The first method involved converting an 80mm diameter circular blank into a pentagonal cup through a drawing operation, while the second method involved redrawing a cylindrical cup into a pentagonal shape. The study also analyzed the impact of these methods on the drawing load, stress/strain distributions, and thickness distributions. The finite element method software, ANSYS 20, was employed for numerical simulations. The results showed that the first method had a significantly higher punch load than the second method. However, the pentagonal cup produced using the first method had a greater thickness reduction towards the cup wall curvature compared to those produced using the second method. Therefore, the second method was considered ideal for manufacturing a pentagonal cup because it resulted in a lower degree of thinning at the cup curvature and a more uniform distribution of thickness, stress, and strain. In conclusion, this research highlights the importance of deep drawing in the manufacturing industry and emphasizes the need to choose the appropriate forming method to achieve optimal results.

### ARTICLE INFO

**Handling editor:** Israa A. Aziz

#### Keywords:

Pentagonal cup  
Deep drawing  
Cup wall  
Drawing force  
Strain thickness

## 1. Introduction

Deep - drawing is among the most popular production techniques. This method may be used to make components with a variety of shapes, including those with simple and complicated geometries [1]. Complicated-shape drawing is characterized by a unique forming feature due to the presence of metal flow irregularities and very complex distortion processes. As a result, complex-shaped formation is more complex than producing simple forms, such as cylindrical, rectangular, square, and conical cups [2,3]. The technique of deep drawing has been the focus of a great number and variety of investigations, and these investigations have been carried out for symmetric as well as axisymmetric shapes. Kushwaha et al. [4] investigated the drawing process experimentally and numerically in order to make cone-shaped cups with no need for a blank holder. Studies have been conducted to investigate how geometry influences the process of producing sheet metal. When compared to the traditional method of deep drawing, the results obtained from the punch that did not have a blank holder are superior. And using the geometry that is currently available, Cone cups were fabricated without finding any problems throughout the process. Saleh et al. [5] developed an innovative method to draw elliptical components by eliminating the need for the blank holder altogether and instead using an elliptic forming die. This method was characterized as employing an ellipse-forming die to draw an elliptical portion. By using a punch that is elliptical in shape with a hollow center, an elliptical blank is pushed into a corresponding die to create an elliptical product. When a die has a clearance of (1mm) and blank thickness (1mm), the part that is created has the greatest ability to be formed, and there are no wrinkles on the part, but it has a smaller earring. Waleed and Ali [6] studied the effect of radial clearance (RC) on the stress and strain distribution during astral deep drawing. There are three different radial clearance values employed in this analysis ( $1.1t_0$ ,  $1.2t_0$ , and  $1.3t_0$ ), and the findings indicated that the highest drawing force value

was 55kN when the clearance value was 1.1mm. also, when there was a clearance of (1.1mm) at the minor axis, the highest effective stress was measured as (674 MPa), and the maximum strain was (0.973). Atul and Lenin [7] analyze the analytical and numerical methods used to develop and optimize the multi-stage deep drawing process of drawing a cylinder cup. Tool geometry and process factors are focused on to reduce defects like thinning, thickness, and wrinkling from the product. This detailed analysis is performed using a three-dimensional finite element model. The findings show that the suggested design process sequences may be carried out effectively and without any failure. Karem and Adil [8] the thickness of the cup wall, strain distribution throughout the wall of the drawn part, the earring form, the pinch force, and the height of the drawn square cup were all studied experimentally and theoretically in relation to the radius profile of the die and punch and the shape and size of the blank. A finite element (ANSYS 11) software, was used to create a dimensional model of a square cup. The results show, that when a square blank was utilized, an excessive number of earrings appeared from the cup. While the best results were obtained using the circular blank, Gowtham et al. [9] studied how changing the die nose radius affected the deep drawing formability of 6061 aluminum alloy while holding all other parameters constant (including punch nose radius, coefficient of friction, and blank thickness). Aluminum alloy 6061 was utilized in the deep drawing procedure, and the finite element software DEFORM-3D was used. The drawing forces were found to increase with decreasing die shoulder radius, leading to earring and stretching marks on the drawn component. Dou and Xia [10] used both simulation and practical testing. In order to have a better understanding of the drawing and redrawing deformed method that takes place in the pyramid cup during the forming procedure. The findings indicated that the material was extruded most thickly at the piece's terminal edge and that it was thinnest at the punch's corner. More even thickness distribution constitutes the second stage of redrawing. Obaeed [11] examined how drawing speed and lubricant influence the success of the direct deep drawing procedure (DDP) in creating square cups. This study was accomplished via the use of finite element modeling and experimental research on a mild steel (AISI1008) cylinder that was 80mm in diameter and 0.5mm in thickness. High sheet formability was re-evaluated to have been reached at low punch speed, and it was discovered that using lubricant with dry drawing did not affect formability. Jweeg et al. [12] studied the distribution thickness when deep drawing a conical cup and found that it was affected by several process factors including the angle of the die wall, the punch speed, the thickness of the sheet, and the type of metal used the investigation's findings demonstrated that thinning was made worse if the die wall angle, sheet thickness, Lankford coefficients, or R-values were increased. Variation in thickness was not significantly affected by the speed at which the punch was applied. Choudhari and Khasbage [13] research included both numerical modeling and experimentation to study the drawing process of the square cup and examined the impact of blank shape, blank thickness, load, and lubrication on thinness and wrinkle formation. The findings showed that a 2mm thick blank is completely free of thin areas and wrinkles and that its formability is better than that of thinner blanks (1 mm and 0.8 mm). Since the deep drawing process is used to produce simple shapes, the present work focused on producing complex shapes in the deep drawing process by using two methods, the first method includes a direct drawing for a circular blank while the second method includes converting the cylindrical cup to complex shapes.

## 2. Numerical Simulations

As digital computers have advanced to meet the demanding computing needs of finite element analysis, the finite element approach has become more popular for solving difficult engineering problems [14,15]. The finite element model formulation process involves defining the geometry, discretizing it into small elements, assigning material properties and boundary conditions, and solving the equations of motion. The analysis method used depends on the nature of the deformation process, with static analysis being the most common method for deep drawing applications. In the present investigation, the working blanks that are used in the deep drawing operations are taken from low carbon steel sheet to produce a pentagonal cup in deep drawing operations with a diameter of (41 mm) and a height of (30 mm) as shown in Figure 1.

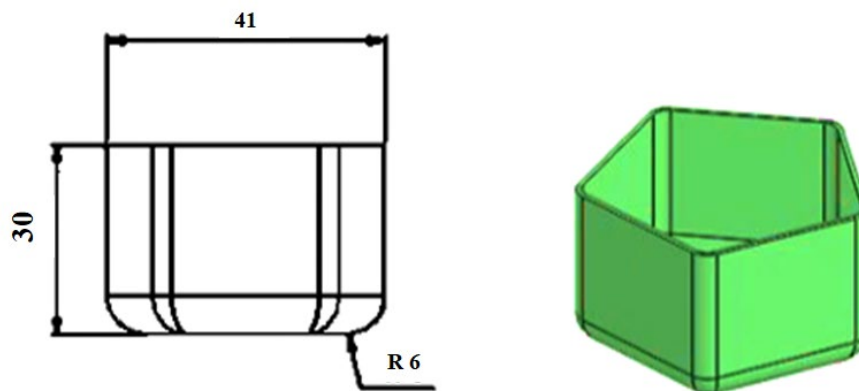

Figure 1: Pentagonal shape

The models for the two different forming procedures depicted in Figure (2) were constructed with the help of ANSYS workbench version 20 for the first method of forming and the second method. To simulation of the circular blank in the deep drawing process was carried out using the SOLID 185 element type. In this simulation, the punch, die, and blank holder were considered rigid bodies, while the circular blank was assumed to be a deformable body. The contact interface between the tools and the circular blank was automatically simulated using ANSYS 20. To represent the rigid tools during the drawing operation, the TARGE170 element was used, while the CONTA174 element was used to represent the deformable circular blank. During the redrawing operation, the TARGE170 element was used to represent the rigid tools (die and punch). Three contact areas between a blank and die, blank and punch, and blank and punch guide [16]. For the ANSYS Workbench simulation, the method of automatically meshing elements and body sizing was employed. The tool components, including the punch, die, and blank holder, were meshed using the element size of 3 mm. On the other hand, the blank material was meshed using a tetrahedral mesh and body sizing method, with an element size of 2 mm.

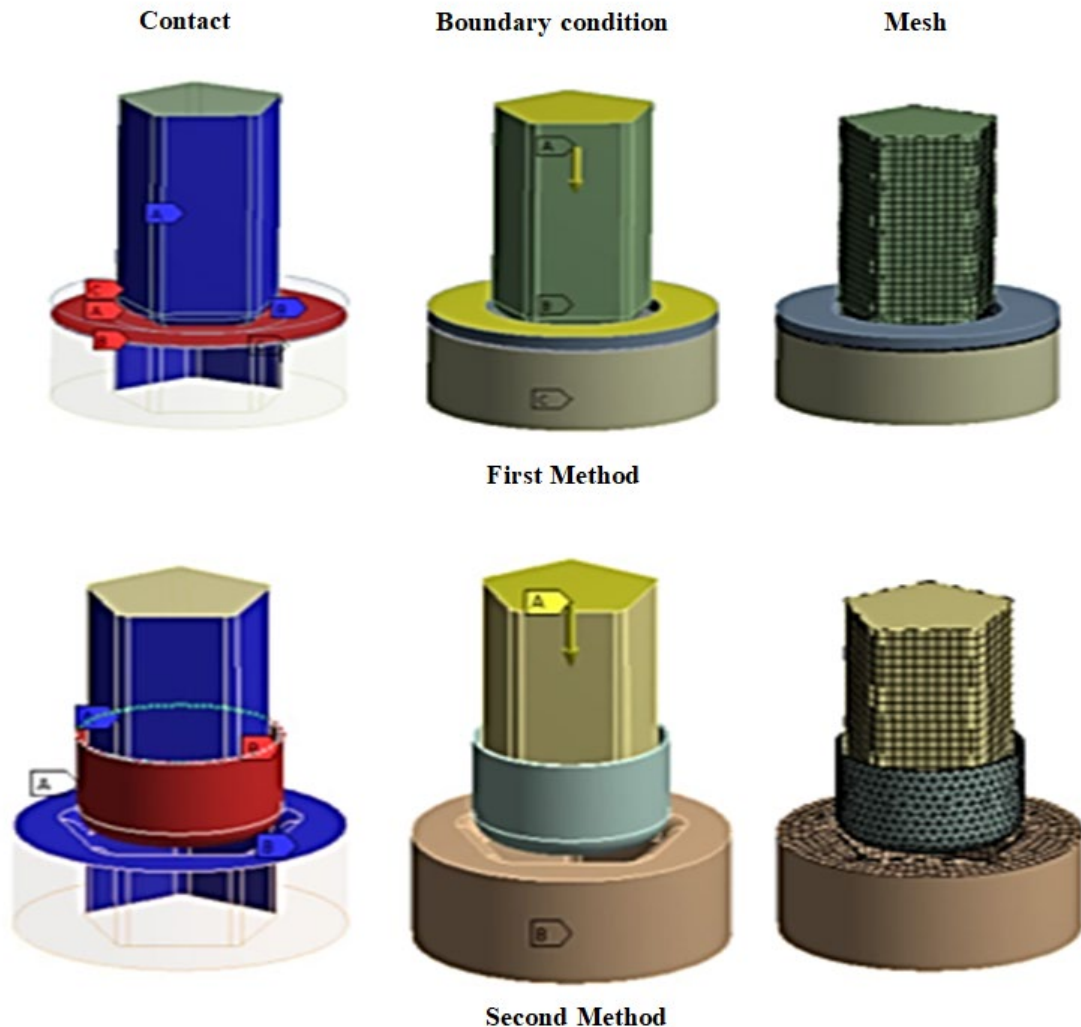

Figure 2: Engine simulations of the drawing die

### 3. Experimental Procedure

The deep drawing experiments were conducted using a WDW200E mechanical. In order to produce a pentagonal cup, experimental instruments, such as a die and a punch, were designed and manufactured as shown in Figure 3 (A-D). The punches and dies that were employed in the procedures were fabricated using tool steel. For the purpose of carrying out the experimental work, a low-carbon steel alloy with a thickness of 0.7 mm and a diameter of 80 mm was used in this research. A pentagonal cup with measurements of  $(41 \times 34.692 \text{ mm})$  and a wall height of (30 mm) was created using two separate techniques, the first technique of forming involves drawing a blank to create a pentagonal cup.

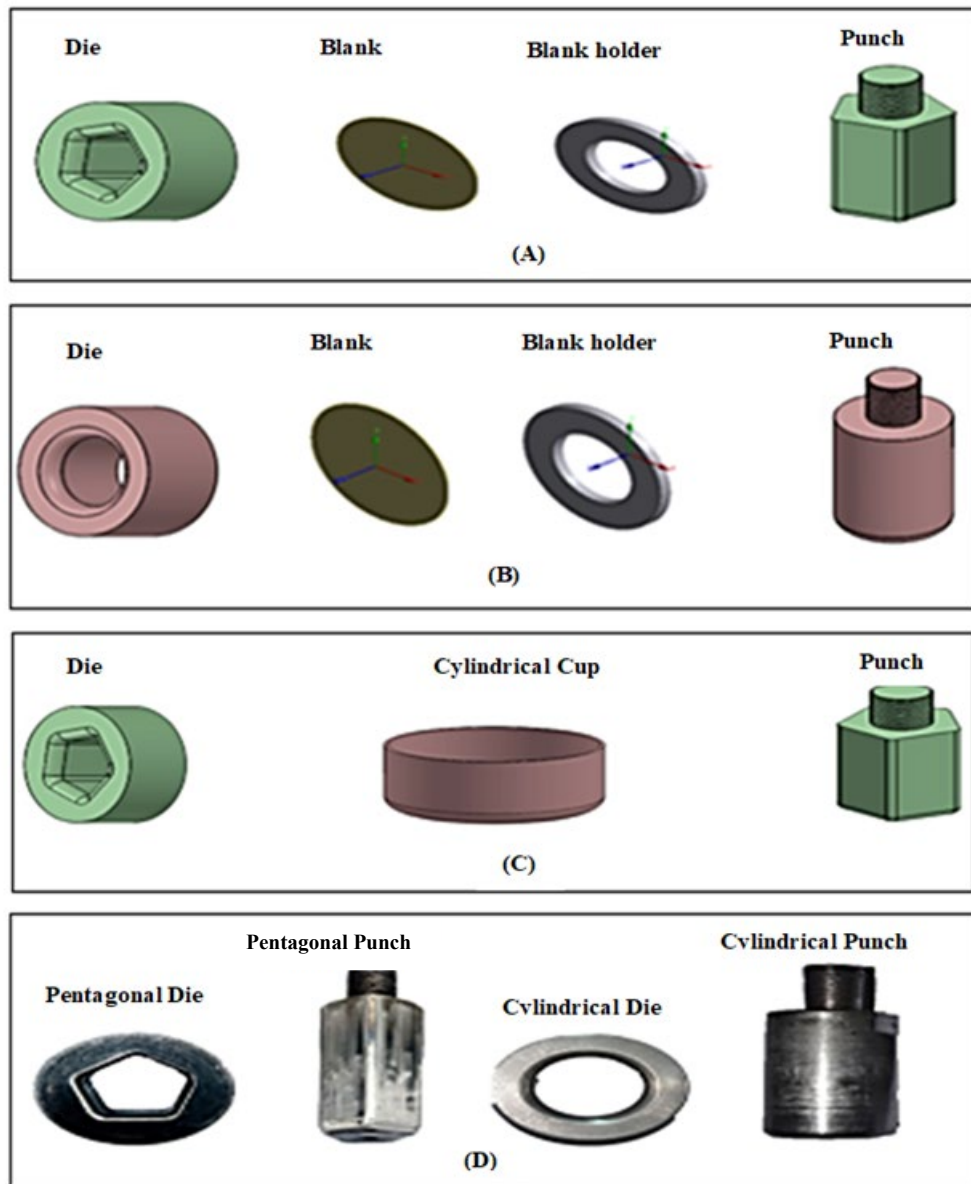

Figure 3: The drawing tools that were used for the two different processes of formation

The cylindrical cups are used as a starting point for the second method of cup formation, which involves redrawing the cylindrical cups into pentagonal cups. Both of these procedures result in the production of a pentagonal cup, as seen in Figures (4 and 5). All experiments were conducted at Laboratory Strength of Material in Production Engineering Department.

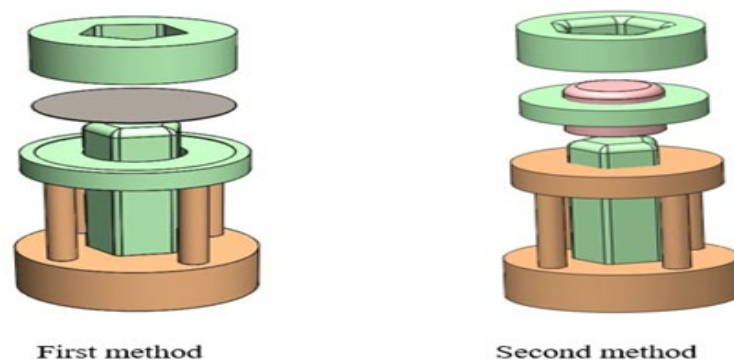

Figure 4: The mechanics of two forming methods

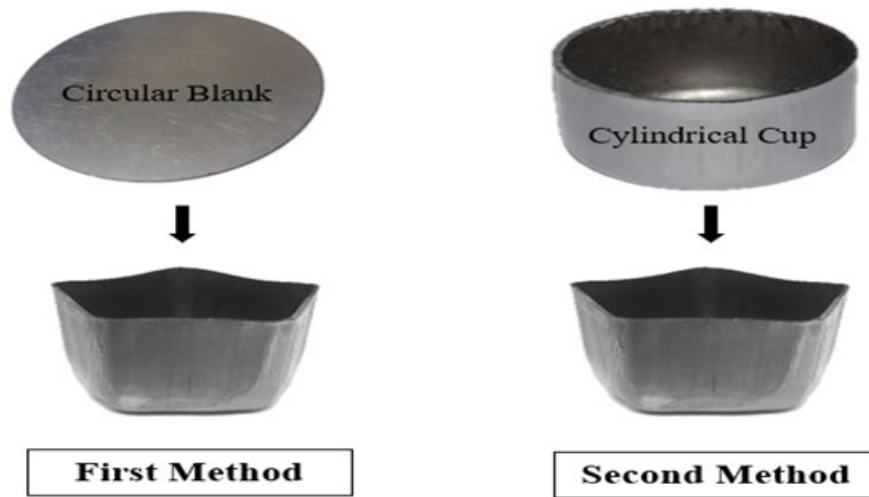

Figure 5: The pentagonal cups that were made using both of the forming procedures

### 3.1 Strain Measurement

In order to analyze the strain distribution inside the cup during the drawing process. At the top of the surface of the sheet blank, a grid pattern of unified center circles with (5,10,15,20,25,30,35,40) mm radii was printed using a fiber laser printer, as illustrated in Figure 6. To determine the thickness of the pentagonal cup wall, the drowned pentagonal cup was divided into two pieces using a wire cut machine as shown in Figure 7 (A and B). After deformation, the cup wall thickness and variations in the grid circular were measured using a tool microscope and thickness micrometer. Strains in the radial and thickness directions were determined using formulas (1) and (2), while strains in the hoop direction and the effective strain were computed using Equations (3 and 4) [17].

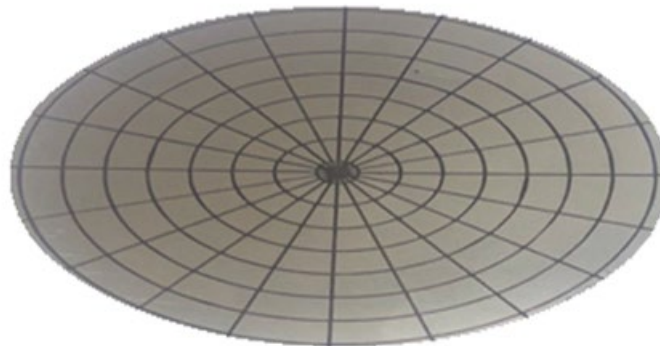

Figure 6: Circular grids pattern on the blank surface by utilizing a fiber laser machine

$$\epsilon_t = \ln \frac{t}{t_0} \quad (1)$$

$$\epsilon_r = \ln \frac{R}{R_0} \quad (2)$$

$$\epsilon_\theta = -(\epsilon_r + \epsilon_t) \quad (3)$$

$$e_{eff} = \sqrt{\frac{2}{3}(\epsilon_r^2 + \epsilon_t^2 + \epsilon_\theta^2)} \quad (4)$$

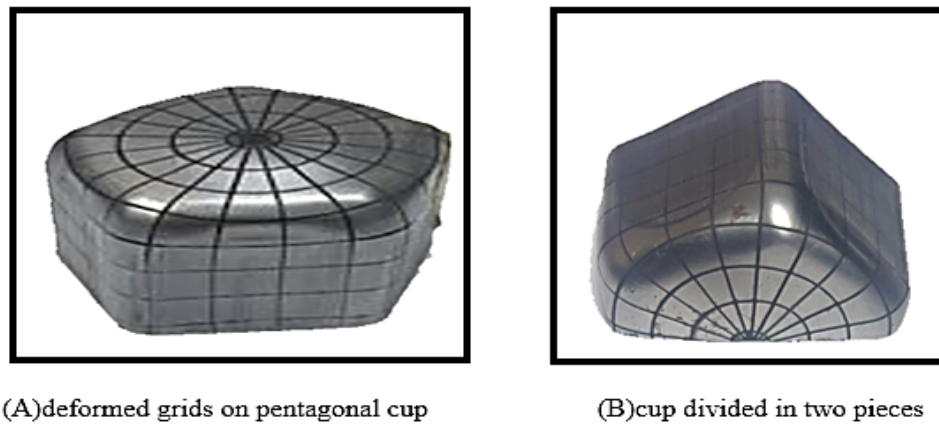

Figure 7: (A) Pentagonal cup with deformed grids, (B) cup divided

#### 4. Results and Discussion

Figure 8 show a comparison of the drawing force of two method using the production of the pentagonal cup which includes 1<sup>st</sup> method of drawing a circular blank into a pentagonal cup, while 2<sup>nd</sup> method of converting a cylindrical cup to a pentagonal shape using experimental methods and simulation techniques, figure explains that the maximum drawing force for 1<sup>st</sup> method (circular blank to pentagonal cup) where reached to the value 41KN EXP, 34KN FES, due to occurs bending and drawing process also drawing ratio of 1<sup>st</sup> method higher than the 2<sup>nd</sup> method (converting cylindrical cup to pentagonal shape). The quantity of metal drawn by the first forming technique is bigger than the proportion of metal drawn by the second, and the first method's reduction percentage is higher than the second's, when compared with the previous literature [18], our findings showed strong concordance.

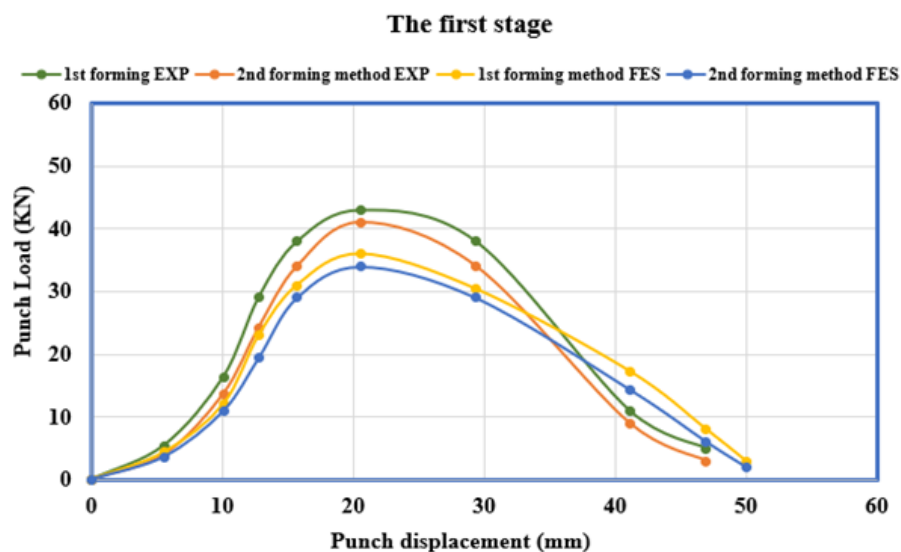

Figure 8: The effects of formation processes on drawing force

Figure 9 (A,B) compares the thickness distribution along the cup walls (side area, curvature area) obtained by forming a circular blank and a cylindrical cup into the pentagonal cup. As illustrated in the figure, with both cup-forming processes, the cup's base has the same thickness due to the combined effects of friction, and drawing force plays an essential role in preventing any deformation of the area just below the punch's flat face. Maximum reduction in thickness is seen in the curvature region (10.31 % FES and 9.26 % EXP) when converting a cylindrical cup into a pentagonal cup than when creating a circular blank since the metal's highest stress is concentrated in the curvature area, this explains the difficult flow of metal in this zone. Following then, the thickness change from one region to another as the intensity of the stress changes. It can be observed that in the cup produced in 2<sup>nd</sup> method, a more regular thickness is achieved throughout all areas of the final product. Similar findings were observed in the previous literature [18,16].

Figure 10 (A,B) compare the effective strain distribution throughout the cup walls of the side and curvature area of drawn cups by different forming methods, Figure shows that the various forming processes have almost the same trend in the effective strain distribution. Because there is so little deformation at the cup's base, the effective strain values are close to zero. Effective strain ( $\epsilon_{eff}$ ) starts to increase and reaches its greatest value near the end of the cup because of stress along the radial axis. The

first forming procedure produced the largest values of the effective strains at the cup wall's end and in the curvature region. Good agreement was found between these findings and the previous literature [19].

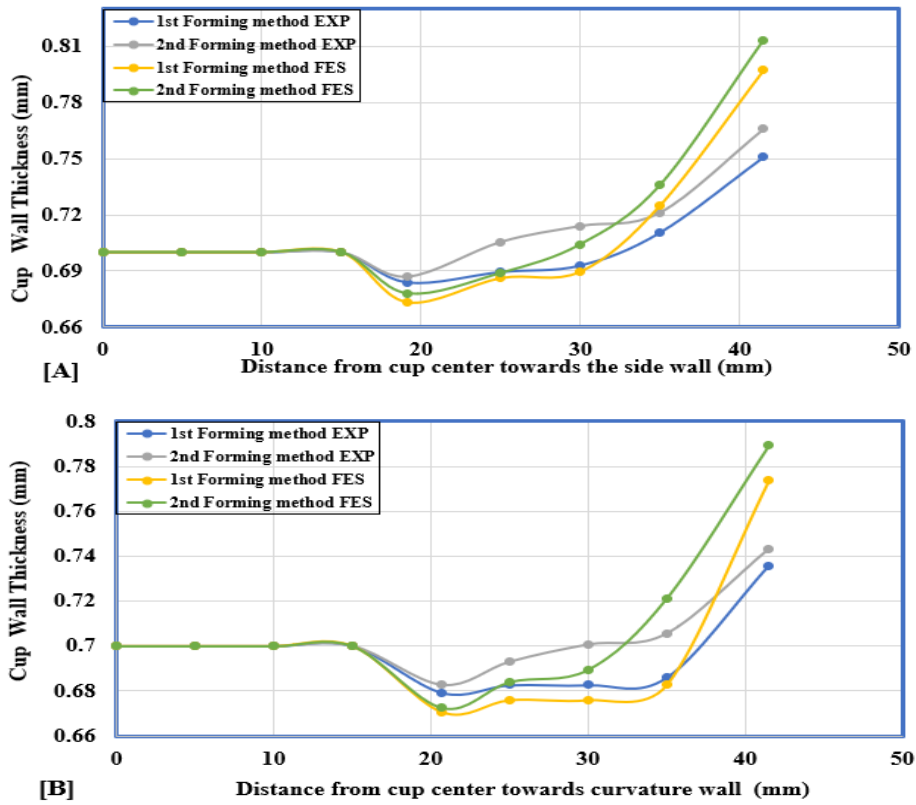

Figure 9: The various forming processes affect the thickness distribution

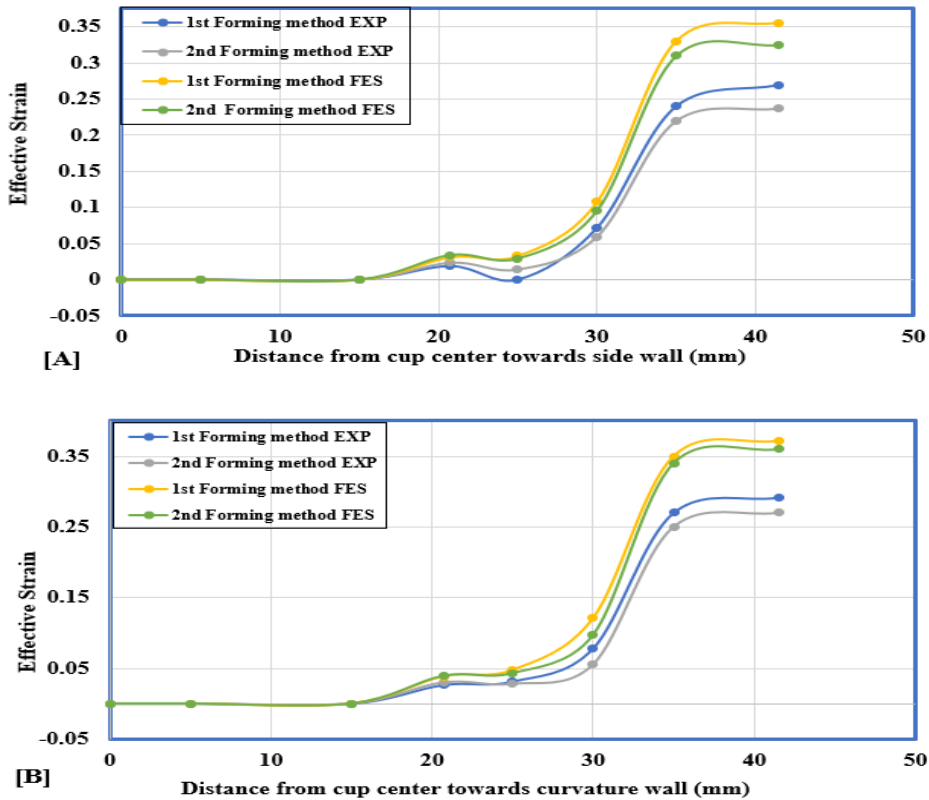

Figure 10: Effect of forming method on the distribution of strain

Figure 11 depicts how the distribution of stresses all across the cup wall is affected by the forming techniques. It is obvious that the equivalent stresses at the bottom of the cup are zero, after then the stress builds up, until peaking around the top of the cup, where it varies from area to region. Additionally, the findings demonstrate that the effective stress for the shell cup wall using the second forming technique exhibits is similar to the behavior of the first forming method. However, its value is not constant and the effective stress is greatest with the first forming procedure at the edge cup's.

Figures (12 and 13) depict the step-by-step process of creating a pentagonal cup in ANSYS using two different methods. The first method involves drawing the pentagonal cup from a circular blank, while the second method consists of converting a cylindrical cup into a pentagonal cup and comparing the effective strain distribution along the sidewall of the two methods. It was found that the first method resulted in the highest value of effective strain for all cup zones, with a maximum value of 0.657 FEM compared to the second method. However, the second method showed better regularity of strain distribution over the cup wall.

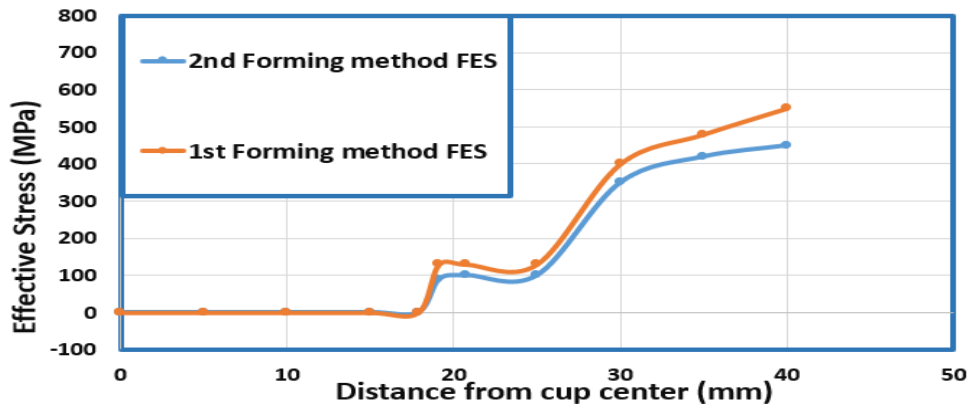

Figure 11: Effect of forming method on the distribution of strain

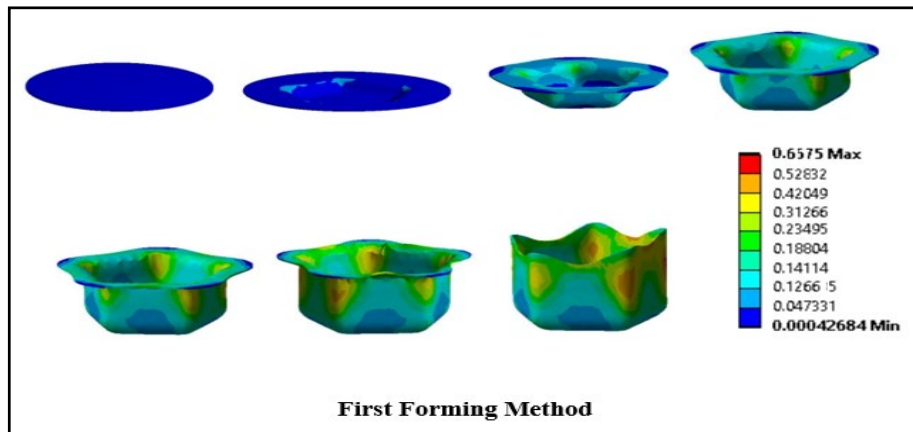

Figure 12: Different stages of creating a pentagonal cup from a flat circular sheet

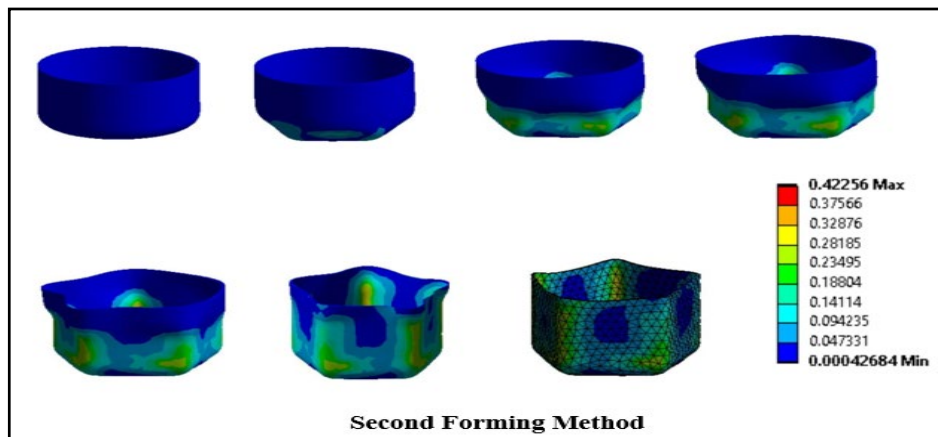

Figure 13: Various stages involved in the process of creating a pentagonal cup through the redrawing of a cylindrical cup



## 5. Conclusion

From the experimental results, it can be conclude the following:

- 1) Deep drawing is able to form complex shapes like pentagonal shapes.
- 2) The first forming procedure resulted in the greatest thickness reduction due to high stretching.
- 3) The second forming procedure resulted in the most uniform thickness distribution as well as the lowest stress and strain values.
- 4) Convert method is the best direct method to produce a pentagonal cup with minimal thinning at the curvature wall.
- 5) The metals distribute more evenly and flow more freely along the side wall region than the curvature wall area. As a result, the thinness and tearing are more apparent in the cup's corner area.
- 6) The differences between the results of experiments and simulations are on average between (5-25%).

## Acknowledgment

The authors appreciate the project's assistance and encouragement from the Department of Production Engineering at the University of Technology.

## Author contributions

Conceptualization, Z. Mohsein. and W. Jawad; methodology, A. Abed; software, Z. Mohsein; validation, Z. Mohsein, W. Jawad. and A. Abed; formal analysis, Z. Mohsein; investigation, Z. Mohsein; resources, Z. Mohsein; data curation, Z. Mohsein; writing—original draft preparation, Z. Mohsein; writing—review and editing, Z. Mohsein; visualization, Z. Mohsein; supervision, Z. Mohsein; project administration, Z. Mohsein. All authors have read and agreed to the published version of the manuscript.

## Funding

This research received no specific grant from any funding agency in the public, commercial, or not-for-profit sectors.

## Data availability statement

The data that support the findings of this study are available on request from the corresponding author.

## Conflicts of interest

The authors declare that there is no conflict of interest.

## References

- [1] N. P. Pradipkumar , K.H. Inamdar, A Review on Deep Drawing of Rectangular Shaped Parts, *Asian J. Convergence Technol.*, 2 (2016)1-3.
- [2] B.S. Kang , W. J . Song , T. W. Ku, Study on process parameters and its analytic application for non-axisymmetric rectangular cup of multistage deep drawing process using low carbon thin steel sheet, *Int. J. Adv. Manuf. Technol.*, 49 (2010) 925–940. <https://doi.org/10.1007/s00170-009-2450-8>
- [3] A. I. Mohammed, Analysis of Forming Complex Cup by Drawing Process , *IOP Conf. Ser.: Mater. Sci. Eng.*, 881 , 2020, 012055. <https://doi.org/10.1088/1757-899X/881/1/012055>
- [4] V. K. Kushwaha. , V. Babel , D. N .Verma , Experimental investigation of sheet metal forming without blank holder using punch stamping process , *Int. J. Res. Emerging Sci. Technol.*, 4 (2017) 1-38.
- [5] A .H . Saleh,,H. A. Ameen , O. H. Abed Al Radh , Deep drawing of sheet metals using the friction-actuated blank-holding technique , *Int. J. Eng. Technol.*, 7 (2018) 578-583. <https://doi.org/10.1088/1757-899X/881/1/012055>
- [6] W. K .Jawad , A. T . Ikal, Effect of radial clearance on stress and strain distribution in the astral deep drawing , *J. Eng. Technol.*, 37 (2019). <https://doi.org/10.30684/etj.37.8A.4>
- [7] T .S .Atul , L .Babu , M. Chinnapandi , Multi-stage deep drawing process of axis-symmetric extra deep drawing steel cylindrical cup, *J. Eng. Res. Express*, 2 (2020) 025008. <https://doi.org/10.1088/2631-8695/ab872a>
- [8] K. M. AL-Darraj, A. S. Jaber, Experimental and theoretical study of square deep drawing, *J. Eng. Technol.*, 29 (2011) 2456-2467.
- [9] K. Gowtham, K. Srikanth, K. Murty, Simulation of the effect of die radius on deep drawing process, *Int. App. Res. Mech. Eng.*, 1 (2012) 12-17. <https://doi.org/10.47893/IJARME.2012.1043>
- [10] S. Dou, J.Xia , Numerical analysis of sheet metal drawing and redrawing process, *J. Eng. Des.*, 17 (2015) 625-630.

- [11] N.H.O baed , Numerical and experimental explorations for the formability of drawing square cups through deep drawing operation, Eng. Technol. J., 38 (2020) 1316-1326. <https://doi.org/10.30684/etj.v38i9A.1340>
- [12] M. J .Jweeg, A. I. Mohammed, and M. S .Jabbar, Investigation of Thickness Distribution Variation in Deep Drawing of Conical Steel Products , Eng. Technol. J., 39 (2021) 586-598. <https://doi.org/10.30684/etj.v39i4A.1908>
- [13] C.S. Choudhari, S.S. Khasbage, Experimental investigation of forming parameters for square cup deep drawing process, Mater. Today: Proc., 44 (2021) 4261-4267. <https://doi.org/10.1016/j.matpr.2020.10.543>
- [14] Barkanov, E. Intriduction to the Finite Element Method, Institute of Materials and Structures, Faculty of Civil Engineering, Riga Technical University, 2001.
- [15] J. N. Reddy, An Introduction to the Finite Element Method, McGraw-Hill series in mechanical engineering, 1993.
- [16] A.Ghosh, A.K. Mallik, Manufacturing Science, Affiliated Ease-West Press Publishers Ltd., India,1985.
- [17] S. Kajikawa, T. Takasan, T. Kuboki , K. Tamaoki, K. onishi, A. Gunji, And A. Yamauchi, Finite element analysis of multi-stage deep drawing for forming deep rectangular case with high aspect ratio, Presentations and videos to 16th Int. Conf. Comput. Plast., IS02, 2022. <https://doi.org/10.23967/complas.2021.032>
- [18] K. H .Mukhirmesh , W. K. Jawad , The procedure of experimental work and finite element simulation to produce spline shape multi-stage deep- drawing operation , Conf. Ser. Mater. Sci. Eng., 2021, 1094-012133. <https://doi.org/10.1088/1757-899X/1094/1/012133>
- [19] C.S. Choudhari, S.S. Khasbage, Experimental investigation of forming parameters for square cup deep drawing process, Mater. Today. Proc., 44 (2021) 4261-4267. <https://doi.org/10.1016/j.matpr.2020.10.543>