

Process Capability Evaluation for a Non-normally Distributed One

Dr. Mahmoud Abbas Mahmoud

Production and Metallurgy Engineering Department, University of Technology/Baghdad
Email: dr.mahmoudalnaimi@yahoo.com

Samah Ali Aufy 

Production and Metallurgy Engineering Department, University of Technology/Baghdad

Received on: 30/1/2012 & Accepted on:4/7/2013

ABSTRACT

The common process capability indices (PCIs) C_p , C_{pk} , C_{pm} are widely used in practice. The use of these PCIs is based on the assumptions that process is in control and its output should be normally distributed. In practice normality is not always fulfilled. Therefore, the use of common PCIs leads to erroneous in capability evaluation. In this paper, capability evaluation for non-normally distributed process is carried out in industrial environment with two approaches. The first includes transforming data to normally distribute by Box-Cox transforming method then using the common PCIs. This method failed to transform these data. The second approach includes the use non-normal percentile method with Burr XII distribution. This paper proves that the second approach is more effective in evaluating the capability of this process. Practical case is applied in the State Company for Electrical Industries (SCFEI) particularly in (Water Pump) factory and Minitab 16 Software is used to reduce the long calculation of statistical values and to plot control charts.

Keywords: Process Capability, Non-normally Distributed Data, Process Capability Index.

تقييم مقدرة عملية غير خاضعة للتوزيع الطبيعي

الخلاصة

إن مقاييس مقدرة العملية ($C_p, C_{pk} \& C_{pm}$) هي المقاييس الشائعة الاستخدام في التطبيقات العملية. يستند استخدام هذه المقاييس الى افتراض ان تكون العملية واقعة تحت السيطرة الاحصائية وان تكون مخرجات تلك العملية خاضعة للتوزيع الطبيعي لكن في الواقع العملي هنالك بعض الحالات التي لا تخضع فيها مخرجات العملية الانتاجية للتوزيع الطبيعي وفي هذه الحالة يقود استخدام المقاييس التقليدية لحساب مقدرة العملية الى نتائج غير صحيحة. وفي هذا البحث تم تقييم

٢٣٤٥

مقدرة العملية الانتاجية في حالة تطبيقية لعملية لاتخضع للتوزيع الطبيعي. جرت عملية التقييم بأنتباع اسلوبين الاول يتضمن تحويل بيانات العملية الانتاجية الى التوزيع الطبيعي بأستخدام طريقة Box-Cox للتحويل ثم احتساب مقدرة العملية بأستخدام المقاييس التقليدية ولكن هذه الطريقة فشلت في تحويل تلك البيانات. اما الاسلوب الثاني تم بأستخدام توزيع Burr XII مع طريقة (non-normal percentile) لحساب مقدرة العملية وقد اثبتت هذه الطريقة نجاحها بأيجاد مقدرة العملية. تم تطبيق الحالة العملية في الشركة العامة للصناعات الكهربائية في مصنع مضخات الماء الخاصة بمبردات الهواء وقد استخدمت برامجية Minitab 16 في حساب بعض القيم الاحصائية ولرسم المخططات اللازمة للتطبيق.

INTRODUCTION

In the field of quality control, process capability is used to compare the output of a process to the specification limits of the product to be produced. Process capability indices (PCIs) are widely used to measure the inherent variability of a process and thus to reflect its performance. The analysis of process capability has the following benefits: Continuously monitoring the process quality through the capability indices in order to assure that specifications supplying information an product design and process quality improvement for engineers and designers and providing the basis for reducing the cost and product defectives [1]. The common PCIs including Cp, Cpk and Cpm are widely used in practice. Cp index considers the overall process variability relative to the specification tolerance, and therefore it only reflects the consistency of the product quality characteristics. Cp can be expressed mathematically as:[2].

$$C_p = \frac{USL - LSL}{6\sigma} \quad \dots (1)$$

Where :

USL=upper specification limit

LSL=lower specification limit

σ =standard deviation

The common index Cpu compares the distance between the process mean and the upper specification limit with the upper half-width of the distribution. Similarly Cpl compares the distance between the process mean and the lower specification limit with the lower half-width of the distribution. Cpk takes into consideration process mean and can be defined as follows:

$$C_{pk} = \frac{\min(USL - \mu, \mu - LSL)}{3\sigma} \quad \dots (2)$$

Where:

μ = process mean

Chen (1988) considered this difference and develops the index Cpm[3].

$$C_{pm} = \frac{USL - LSL}{6\sqrt{\sigma^2 + (\mu - T)^2}} \quad \dots (3)$$

Where

T=target value

The use of these PCIs is based on two assumptions: First, the process monitored is to be in control and second, the output of this process should be normally distributed [2]. To calculate the PCIs, most industries assume the distribution of their process output is normal. Obviously, this assumption is not always fulfilled. In practice, hence a PCIs calculation leads to erroneous interpretations [1]. Process capability indices (PCI) are being extensively applied in industry to assess process capability but the distribution measurements from chemical processes, semiconductor processes, or cutting tool wear processes are often skewed and there is a lack of understanding among quality practitioners that these capability measures are essentially based on statistical theory of normality [4].

Therefore, to overcome this problem, two main approaches have been suggested for modifications of classical PCIs. The first approach includes transforming the non-normally distributed data to normally using mathematical function such as (Box and Cox transformation) then classical PCIs are applied [5]. The second approach has been proposed by Clement (1989) [6] where he proposed the method of non-normal percentiles to calculate $C_{p(q)}$ and $C_{pk(q)}$ indices for distribution using Pearson family of curves. Liu and Chen (2006) [7] has done a study indicating that the Clement method cannot accurately measures the nominal values, especially when the underlying data distribution is skewed to improve estimation accuracy they present a new method in which they suggest to use Burr XII distribution instead of Pearson family of curves in the Clements method.

THEORETICAL BACKGROUND

In this section a brief review of the two different methods that are applied in this paper is presented.

BOX-COX TRANSFORMATION METHOD

In order to use classical PCIs for evaluating capability of non-normally distributed process we must first transform data to normally. Box and Cox (1964) [6] analyzed the family of power transformations and provided method of selecting the optimal transformation from this family. To illustrate the flexibility of the Box-Cox transformation, several probability functions that can be transformed into a normal distribution by means of a power transformation $Y = X^\lambda$ transformation $Y = X^\lambda$. If the optimal lambda is close to 0, consider accepting the model $Y = \ln(x)$ and if the optimal lambda close to 0.5 the model $Y = \sqrt{X}$ [8] to understand as shown in Figure (1).

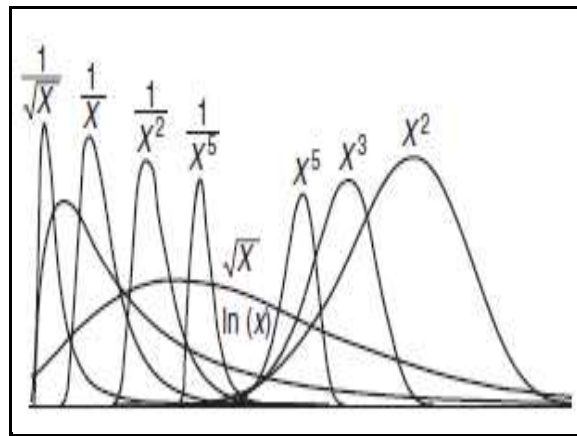

Figure (1) Probability Functions of Several Skewed Distributions that May be Transformed into a Normal Distribution by a Box-Cox Transformation [8].

This transformation depends upon a single parameter λ that can be estimated by Maximum Likelihood Estimation method $L_{\max}(\lambda)$. λ can be chosen from the given range and for each chosen λ evaluate.

After calculating $L_{\max}(\lambda)$ for several values of λ within the given range one can plot $L_{\max}(\lambda)$ against λ . The maximum likelihood estimator of λ is the value of λ that maximize $L_{\max}(\lambda)$. Using the optimal λ value, data values for each individual X data are transformed to a normal variate. If the data is transformed, then classical PCIs are applied [9].

Transformation is a good statistical tool to obtain normally distributed data. Obviously, not every process distribution can be transformed into a normal distribution. The Box-Cox transformation is only effective for certain cases of skewed distributions. In general, the power λ is limited to the range (-5,+5) [10].

PCIS CALCULATION WITH BURR XII DISTRIBUTION

The Burr XII distribution was first introduced in literature by Burr (1942) and plays recently an important role in process capability estimation to study the effect of non-normal. Burr (1973) tabled the expected value mean, standard deviation, skewness coefficient and kurtosis coefficient of the Burr distribution for various combinations of Burr XII parameters c and k [11]. These tables allow the users to make a standardized transformation between a Burr variate and another random variate. The Burr (XII) distribution includes twelve types of cumulative distribution functions which yield a variety of density shapes. It combines a simple mathematical expression in the skewness-Kurtosis plan [12] as shown in Figure (2). Limiting values of the parameters it also approximates the curve shape characteristics of normal, lognormal, gamma, logistics. For example the normal density function may be approximated as a Burr XII distribution with $c = 4.85437$ and $k = 6.22665$ [7,13].

Liu and Chen [7] proposed the method of non-normal percentile to calculate PCIs for a distribution of any shape using the Burr distribution. They used the

technique of non-normal percentile estimation for Clement method using Burr XII distribution, which include percent $q = p$ ($LPL \leq \mu \leq UPL$) where UPL is upper probability limit and LPL is lower probability limit, it is quite easy to estimate these three points where the data is normal distribution [1].

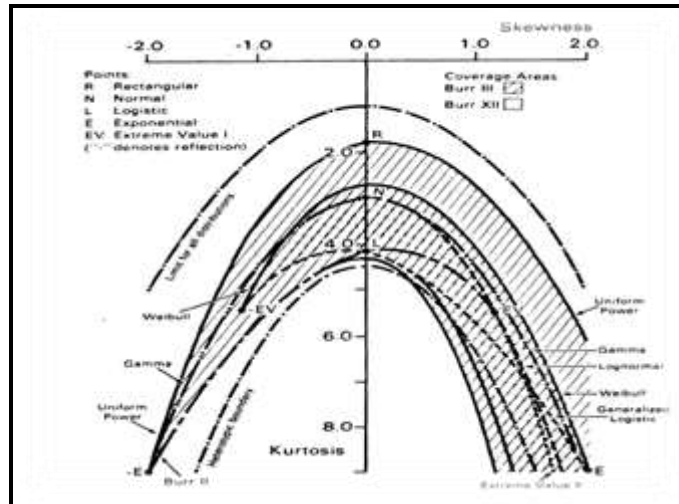

Figure (2) The Moment-Ratio Coverage of the Burr XII Distribution [12].

However, in case of non-normal data process capability indices can be estimated by using the following expressions. This includes replacing the process mean by $q_{0.5}$, UPL by the $q_{0.9985}$ percentile and LPL by the $q_{0.00135}$ percentile of the Burr distribution and that 6σ in $Cp_{(q)}$, $Cpk_{(q)}$, $Cpm_{(q)}$ should be replaced by $q_{0.9985} - q_{0.00135}$ [7,9] as shown in Figure (3).

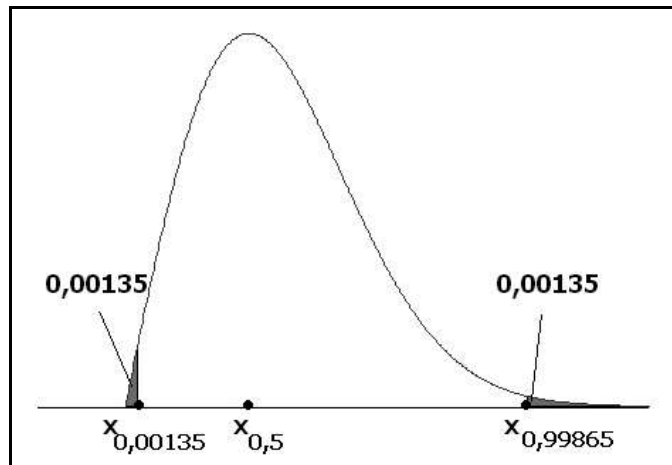

Figure (3) Non-Normal Distribution; Definition of Natural Tolerance [14].

The new PCIs can be calculated by equations (4,7,9,10&11) [7].

$$Cp_{(q)} = \frac{USL - LSL}{X_{0.99865} - X_{0.00135}} \quad \dots (4)$$

Where:

$$X_{0.99865} = \mu + S Z_{0.99865} \quad \dots (5)$$

$$X_{0.00135} = \mu + S Z_{0.00135} \quad \dots (6)$$

S = standard deviation of overall sample (N)

$$Cpu_{(q)} = \frac{USL - X_{0.5}}{X_{0.99865} - X_{0.5}} \quad \dots (7)$$

Where:

$$X_{0.5} = \bar{X} + S Z_{0.5} \quad \dots (8)$$

\bar{X} = mean of sample

$$Cpl_{(q)} = \frac{X_{0.5} - LSL}{X_{0.5} - X_{0.00135}} \quad \dots (9)$$

$$Cpk_{(q)} = \min(Cpu_{(q)}, Cpl_{(q)}) \quad \dots (10)$$

$$Cpm = \frac{USL - LSL}{6 \sqrt{\left(\frac{X_{0.99865} - X_{0.00135}}{6}\right)^2 + (X_{0.5} - T)^2}} \quad \dots (11)$$

THE PROCEDURE OF EVALUATING PROCESS CAPABILITY BY BURR XII DISTRIBUTION

The steps procedure of process capability calculations using the Burr XII distribution are as follows:

1. Calculate: sample mean (\bar{X}) by equation (12) for all observations (N), sample standard deviation by equation (13) [15].

$$\bar{X} = \frac{\sum_{i=1}^N X_i}{N} \quad \dots (12)$$

$$S = \sqrt{\frac{\sum (X_i - \bar{X})^2}{N - 1}} \quad \dots (13)$$

Where:

X_i = reading value

2. Calculate: skewness and kurtosis of the original data as show in following equations [5,6].

$$\text{skwness} = \frac{N}{(N - 1)(N - 2)} \sum \left(\frac{X_j - \bar{X}}{s} \right)^3 \quad \dots (14)$$

$$\text{kurtosis} = \frac{N(N + 1)}{(N - 1)(N - 2)(N - 3)} \sum \left(\frac{X_j - \bar{X}}{s} \right)^4 - \frac{3(N - 1)^2}{(N - 2)(N - 3)} \quad \dots (15)$$

3. Calculate standardized moment of skewness (a_3) and kurtosis (a_4) for the given sample size N as follows[5]:

$$a_3 = \frac{(N - 2)}{\sqrt{N(N - 1)}} \text{skwness} \quad \dots (16)$$

$$a_4 = \frac{(N - 2)(N - 3)}{(N^2 - 1)} \text{kurtosis} + 3 \frac{(N - 1)}{(N + 1)} \quad \dots (17)$$

Use the values a_3 and a_4 to select the standardized lower ($Z_{0.00135}$), mean ($Z_{0.5}$) and upper ($Z_{0.99865}$) percentile from tables in Appendix (I).

4. Calculate the values of percentiles ($X_{0.99865}$, $X_{0.00135}$, $X_{0.5}$) by using equations (5,6and 8):
5. Calculate process capability indices ($Cp_{(q)}$, $Cpu_{(q)}$, $CpL_{(q)}$, $Cpk_{(q)}$, and $Cpm_{(q)}$) using equations (4,7,9,10 and 11).

PRACTICAL APPLICATION

The following case is taken from production line that produces the water pump in the (SCFEI).Particularly, rotor shaft is selected to execute the study due to its

importance since any deviation from the required specification will affects on the normal rotation of the rotor assembly, the tolerances for the rotor assembly which include two parts shaft and rotor are shown in Figure (4) and then causes a lack in pumping force, or it may stop the water pump from work. It has been discovered that there are quality problem in producing the shaft diameter which must be within specification limits $8^{+0.005}_{-0.014}$ mm. To assess the situation of production process, measurements of (25) samples have be taken, each sample consist of (5) items from the final production stage. The measurements are shown in Table (1).

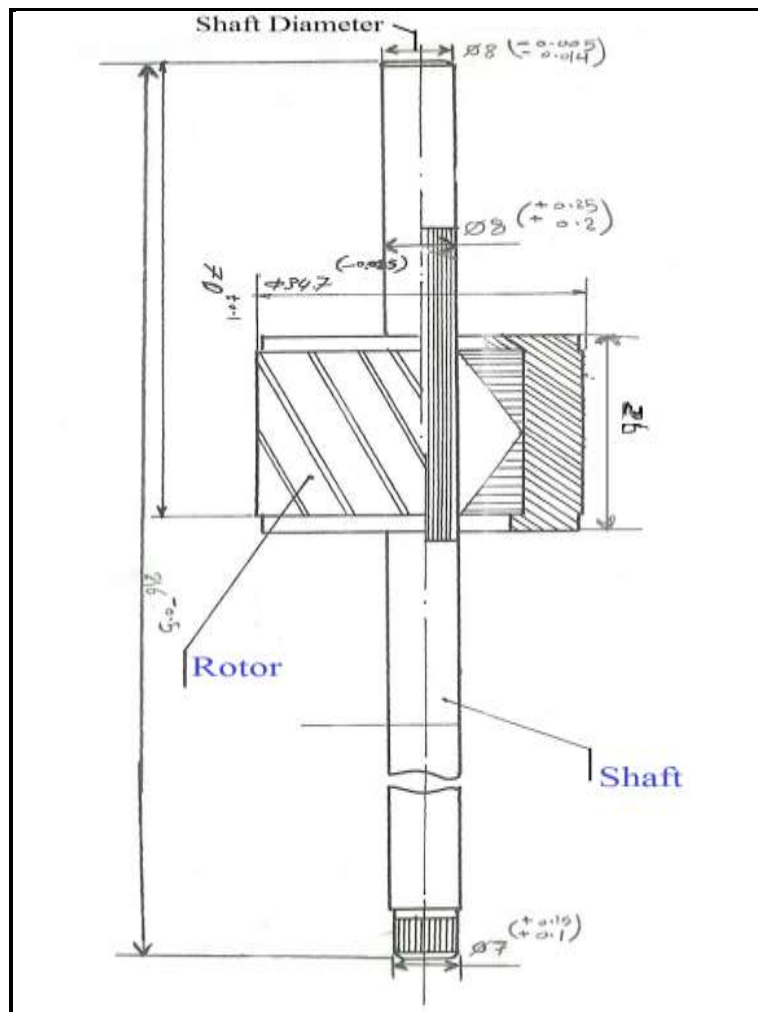

Figure (4) Tolerances of Rotor Assembly [16].

In this study, in order to demonstrate the applicability of the method and to make a clear decision about the capability of the production process. $\bar{X} - R$ charts are constructed using Minitab 16 Software to verify stability of process as shown in Figure (5) which illustrated that the process is stable. The validity of normality was tested by using Anderson-Darling test (AD). The shaft diameter data fail to pass

normality test because the P-value is (<0.005) is smaller than critical value (0.05). This test is done by using Minitab 16 Software the result of test is shown in Figure (6).

Table (1) Measurements of Shaft Diameter.

S.N	Measurements (mm)				
	X ₁	X ₂	X ₃	X ₄	X ₅
1	7.985	7.989	7.989	7.987	7.985
2	7.988	7.988	7.985	7.987	7.993
3	7.986	7.998	7.987	7.992	7.984
4	7.989	7.991	7.997	7.995	7.994
5	7.987	7.984	7.988	7.987	7.987
6	7.984	7.989	7.984	7.984	7.991
7	7.995	7.997	7.991	7.985	7.993
8	7.989	7.985	7.986	7.985	7.984
9	7.985	7.985	7.984	7.990	7.995
10	7.996	7.989	7.987	7.988	7.985
11	7.989	7.986	7.991	7.989	7.990
12	7.995	7.996	7.989	7.996	7.989
13	7.988	7.987	7.989	7.984	7.993
14	7.987	7.992	7.992	7.987	7.992
15	7.989	7.986	7.986	7.988	7.993
16	7.993	7.989	7.984	7.987	7.988
17	7.987	7.985	7.985	7.988	7.993
18	7.986	7.984	7.99	7.998	7.990
19	7.986	7.987	7.989	7.995	7.994
20	7.993	7.991	7.995	7.989	7.986
21	7.986	7.991	7.99	7.991	7.987
22	7.987	7.989	7.984	7.984	7.989
23	7.986	7.986	7.988	7.99	7.993
24	7.988	7.989	7.987	7.986	7.993
25	7.987	7.994	7.994	7.989	7.992

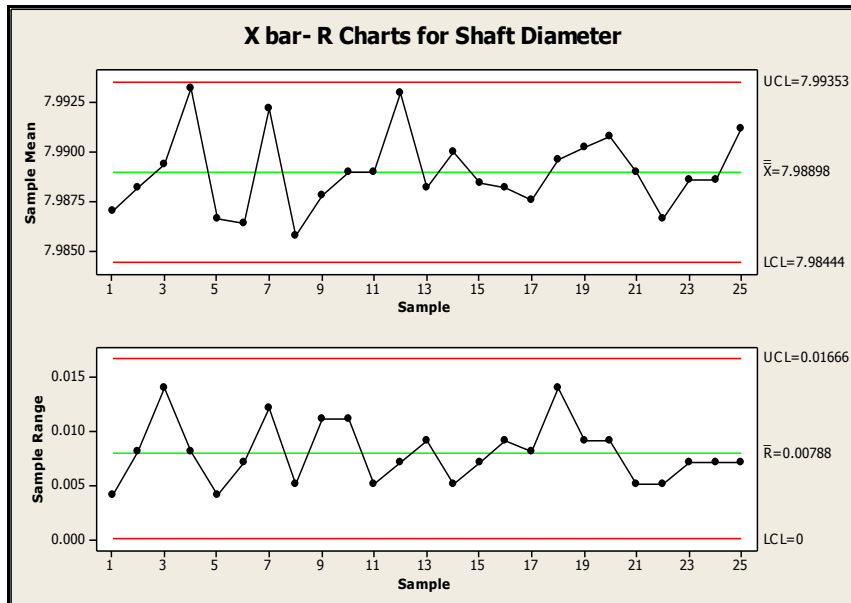

Figure (5) \bar{X} – RCharts for Shaft Diameter.

To overcome the problem that generated from departure of data from normality distribution we transformed data from non-normally to normally distributed data using Box-Cox transformation. The transformed data tested for normality. Test result is shown in Figure (7). We can conclude that this method failed to transform data to normal.

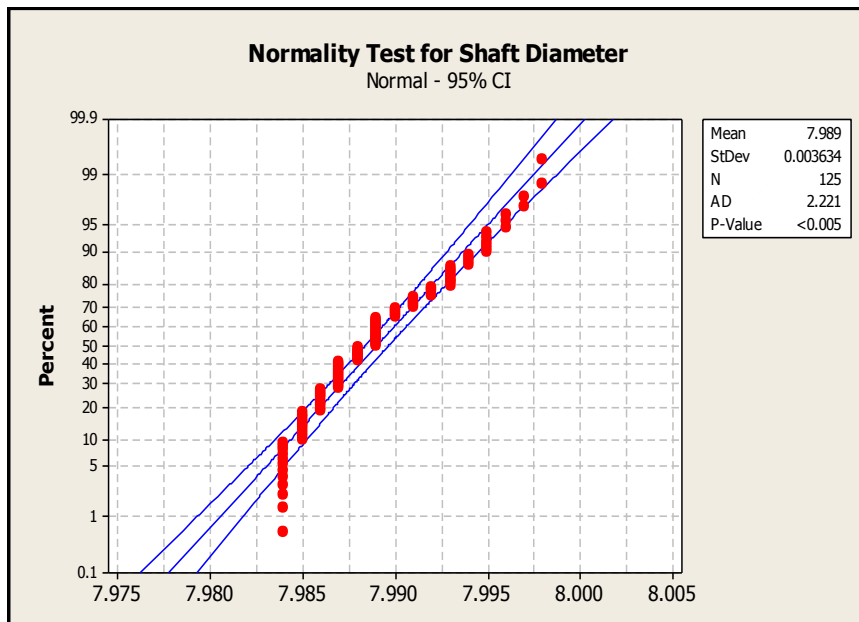

Figure (6) Normality Test for ShaftDiameter.

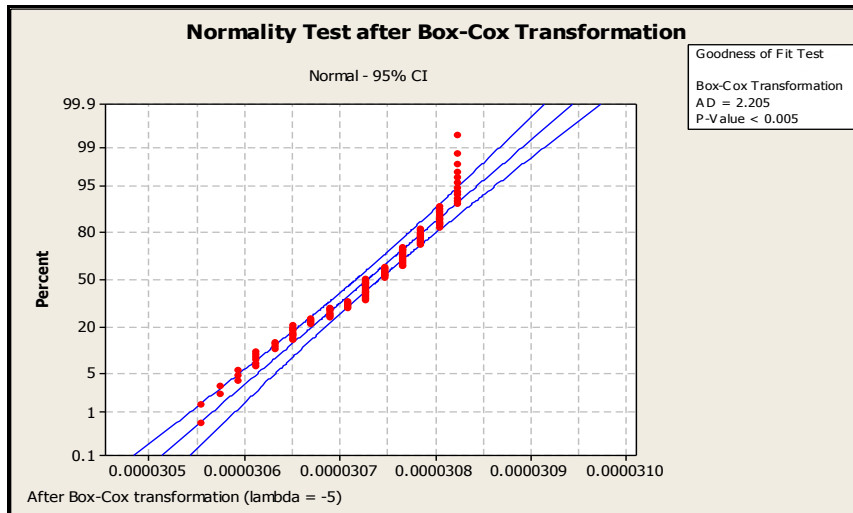

Figure (7) Test for Normality of Transformed Data Shaft Diameter after Box-Cox Transformation.

Therefore, we apply the steps that illustrated in the section which includes that the procedure of evaluating process capability by Burr XII distribution and in this case the calculations are as follows: Mean value (\bar{X}), standard deviation value (S), skewness and kurtosis, all these values are calculated by using Minitab 16 Software. The obtained results are ($\bar{X} = 7.9890$, $S = 0.0036$, skewness = 0.594858 and kurtosis = -0.483056) and shown in Figure (8). The summary of the obtained results for process capability indices are listed in Table (2).

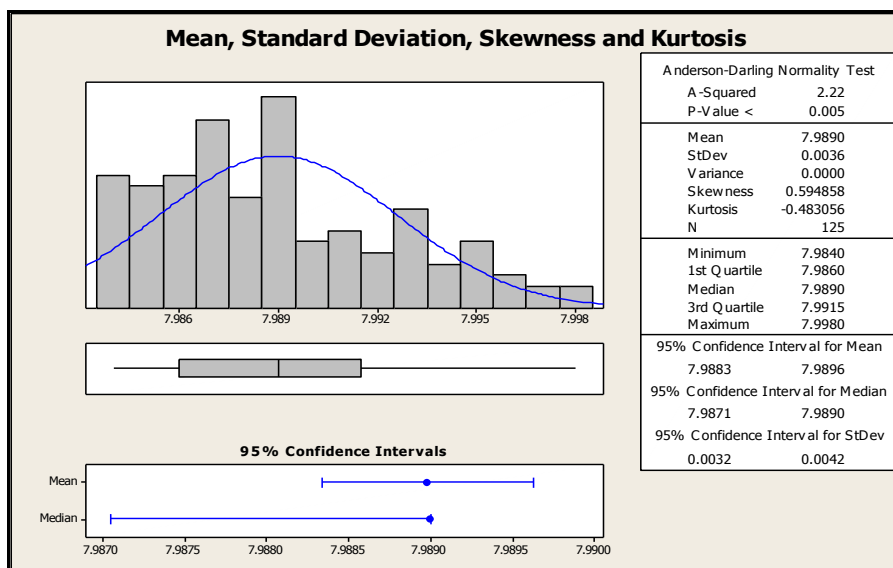

Figure (8) Mean, Standard Deviation, Skewness and Kurtosis.

Table (2) Summary of Calculation Results of PCIs.

Statistical parameters& PCIs	ObtainedResults
a3	0.58
a4	2.48
X _{0.00135}	7.9841148
X _{0.5}	7.9884924
X _{0.9985}	8.0002356
Cp _(q)	0.558
Cp _{U(q)}	0.55
Cp _{L(q)}	0.56
Cpk _(q)	0.55
Cpm _(q)	0.44

CONCLUSIONS

This paper reviewed, implement and compared two methods to calculate process capability for non-normally distributed data. In the first Box-Cox method is used to transform data to normal to apply classical PCIs. In the second a method by modification of Clements method using Burr XII distribution is used. A practical application in real manufacturing environment at the (SCFEL) is presented. The following conclusion are drawn

1. In practice industrial production involves processes that are non-normally distributed. Therefore, the uses of traditional process capability indices to measure capability of such processes give misleading results.
2. Box-Cox method failed to transform data to normally distributed data.
3. The obtained values for process capability shows that the capability of production process for shaft diameter is inadequate due to (Cp_(q)= 0.558, Cpk_(q)= 0.55 and Cpm_(q)= 0.44) and there is shift in the process mean from target value.
4. The process dispersion need to be reduced and the process mean to be shifted to be closer to target value.

REFERENCES

[1]. Pan J.N. and Wu S.L., "Process Capability Analysis for Non-Normal Relay Test Data", *Microelectronic Reliab.*, vol. 37, No. 3, PP. 421-428, 1997.
 [2]. Sagbas A., "Improving The Process Capability of Turning Operation by The Application Of Statistical Techniques", *Material and Technology*, PP.55-59, 2009.

- [3]. Abdolshah, M., Yusuff, R. M., hong, T.S. and Ismail md.Y. B., "Overall Processes Capability Index for Assembly Production Lines", *Journal of Applied Sciences*, Vol. 9, PP. 3764-3769, 2009.
- [4]. Ciflikli C., "Development of Univariate Control Charts for Non-normal Data", Master Thesis, Graduate School of Engineering and Science of Izmir Institute of Technology, 2006.
- [5]. Ahmad, S., Abdollahian M. and Zeephongsekul P., "Process Capability Estimation for Non-normal Quality Characteristics: A comparison of Clements, Burr and Box-Cox Methods", *ANZIAM J.*, Vol.49, PP.C642-C665, 2008.
- [6]. Abbasi, B., Ahmad, S., Abdollahian M. and Zeephongsekul P., "Measuring Process Capability for Bivariate Non-normal Process Using the Bivariate Burr Distribution" *Wseas Transactions on Business and Economics*, Vol. 4, 2007.
- [7]. Liu P. and Chen F., "Process Capability Analysis of Non-normal Process Data Using The Burr XII Distribution", *Int. J. Adv. Manuf. Technol.*, Vol.72, PP.975-984, 2006.
- [8]. Sleeper A. D., "Design for Six Sigma Statistics: 59 Tools for Diagnosing and Solving Problems in DFSS Initiatives" McGraw-Hill Book Company, 2006.
- [9]. Pearn W. L. and Kotz S., "Encyclopedia and Handbook of Process Capability Indices", World Scientific Publishing Co. Pte.Ltd., 2006.
- [10]. Chen T.W., Lin J.Y. and Chen K.S., "Selecting a Supplier by Fuzzy Evaluation of Capability Indices Cpm", *Int. J. Adv. Manuf. Technol.*, Vol.22, 534-540, 2003.
- [11]. Ahmad, S., "Process Capability Assessment for Univariate Multivariate Non-normally Correlated Quality Characteristics", Ph.D. Thesis Submitted to Asian Institute of Technology, Bangkok, Thailand & Technical University Hamburg, Germany, 2009.
- [12]. Lewis, A.W., "The Burr Distribution as General Parametric family in Survivorship and Reliability Theory Applications", Ph.D. Thesis, The University of North Carolina, 1981.
- [13]. Ahmad, S., Abdollahian, M. and Zeephongsekul, P., "Process Capability for a Non-Normal Quality Characteristics Data", *International Conference on Information Technology*, IEEE, 2007.
- [14]. Czarski, A., "Estimation of Process Capability Indices in Case of Distribution Unlike the Normal One", *Archives of Materials Science and Engineering*, Vol. 24, PP. 39-42, 2008.
- [15]. Besterfield, D.H., "Quality Control", McGraw-Hill Book Company, Eight Editions, 2009.
- [16]. The Documents of the State Company for Electrical Industries.

Appendix (I) Adapted from [7].

a_3	a_4	$BZP_{0.00135}$	$BZP_{0.5}$	$BZP_{0.99865}$
0	2	-1.843	0.022	2.396
0	2.2	-1.959	0.037	2.697
0	2.4	-2.076	0.047	2.911
0	2.6	-2.197	0.053	3.078
0	2.8	-2.735	0.008	2.914
0	3	-2.884	0.010	3.081
0	3.2	-3.02	0.011	3.221
0	3.4	-3.148	0.011	3.34
0	3.6	-3.269	0.011	3.442
0	3.8	-3.388	0.009	3.529
0	4	-3.509	0.015	3.609
0	4.2	-3.642	0.001	3.659
0.5	2	-1.225	-0.213	2.258
0.5	2.2	-1.292	-0.173	2.829
0.5	2.4	-1.357	-0.141	3.121
0.5	2.6	-1.421	-0.115	3.325
0.5	2.8	-1.487	-0.093	3.483