



Design of a Boost Converter with MPPT Algorithm for a PV Generator Under Extreme Operating Conditions

Hussein A. Hussein ^{a*}, Ali J. Mahdi ^b, Thamir M. Abdul-Wahhab ^c

^aBabylon Sewerage Directorate, Babylon Provincial Council, Babylon, Iraq.

^bElectrical Engineering Dept., University of Karbala, Karbala, Iraq.

^cElectrical Engineering Dept., University of Technology-Iraq, Alsina'a street, 10066 Baghdad, Iraq.

*Corresponding author Email: 316313@student.uotechnology.edu.iq

HIGHLIGHTS

- The boost converter considered a variable voltage of PV array under weather conditions.
- The designed converter is able to deliver power to grid with the efficiency of 96%.
- The maximum efficiency of the MPPT is about 99%, tested under extreme conditions.

ARTICLE INFO

Handling editor: Ivan A. Hashim

Keywords:

PVG model

Estimating maximum power point (MPP)

Maximum power point tracking (MPPT)

Boost converter design

ABSTRACT

Photovoltaic generators (PVGs) are one of the most popular renewable energy sources (RESs), which achieve 47% of RES in microgrids. The aim of this work is to design and simulate a PVG system with a rated power of about 1,621 kW at the standard test conditions (STC), i.e., 1,000 W/m² and 25°C. The main components of the proposed PVG are 12 PV panels connected in series (the peak power of a PV panel at STC is about 135 W). A DC-DC boost converter is proposed for implementing the maximum power point tracking (MPPT) algorithm. The proposed MPPT algorithm is tested under extreme conditions; a wide range of change in temperature, irradiance, and load variations. The boost converter is designed to verify stable power flow from the PVG to the load. The calculated and the simulation results using MATLAB/Simulink are in good agreements and the maximum efficiency of the implemented MPPT algorithm is about 99%.

1. Introduction

The main drawback to renewable energy sources, including photovoltaic (PV) and wind power, is that they fluctuate in power and can be only intermittently, reliable for energy generation because they rely on natural, not controllable factors such as the Sun and wind. Therefore, an interface system between renewable energy sources and load is needed to meet the specifications of the given load [1]. A power electronic converter may play an important role in an interface system because it can maximize the utilization of renewable sources and contribute to high efficiency renewable energy systems [1]. As a result, designing reliable and highly efficient power converters is one of the most interesting topics in the field of renewable power generation. In principle, the MPPT controller derives the DC-DC converter, which serves as an interface between load and PV cell, by controlling its duty cycle to extract maximum power out of the PV cell based on environmental conditions [2]. The output of DC-DC converter can be used to operate DC load directly. In this paper, Boost converter and P&O algorithm are tested under extreme operating conditions. In literature survey, Hayati Mamur and Rasit Ahiska [3] proposed a DC-DC boost converter with maximum power point tracking (MPPT) based on microcontroller embedded in perturb and observe (P&O) algorithm to obtain maximum power from a newly designed portable Thermoelectric generators (pTEG) in a real TEG system. The matched condition load for the pTEG has been experimentally investigated. Byamakesh Nayak [4] proposed a converter based on maximum power transfer theorem which is dependent on load resistance. Different load resistance is considered for maximum power point tracking (MPPT) with different converter topologies, and it has been observed that buck-boost converter is suitable for any load resistance connected in the PV system. An effort has been taken to suitably choose the control variable which is the output signal of the maximum power point (MPP) tracker. Control variable which is dependent on inputs of MPP tracker is decided based on the stability of the system. Two MPP trackers are designed based on neural-network

(NN) controller and perturb and observe (P&O) algorithm. Arjyadhara Pradhan and Bhagabat Panda [5] designed a basic circuit of boost converter in MATLAB/Simulink with constant DC source voltage. A comparative study has also been done for the converter connected with PV system directly with the converter connected with MPPT tracking technique. Perturb and Observe (P&O) algorithm is implemented for providing the necessary duty pulse and make the system operate at maximum power point (MPP).

2. Estimating the Maximum Power Point (MPP) Under A Wide Range of Actual World Operating Conditions

To estimate the maximum power points at certain environmental condition, first find short circuit current I_{sc} , and open circuit voltage V_{oc} under the measured radiance at a measured module temperature using the following equations [6][7]:

$$I_{sc} = \frac{G}{G_0} * I_{sc(0)} [1 + \alpha(T - T_0)] \tag{1}$$

$$V_{oc} = V_{oc(0)} [1 + \beta(T - T_0)] \tag{2}$$

where G : Irradiance (kW/m^2), G_0 : Irradiance at STC = $1,000\text{W/m}^2$, AM 1.5G), $I_{sc(0)}$: Short circuit current at STC (A), α : Temperature coefficient of I_{sc} (degC-1), T : Module temperature (deg. C) , T_0 :Module temperature at STC = 25°C , $V_{oc(0)}$: Open circuit voltage at STC (V) and β : Temperature coefficient of V_{oc} (degC-1) then find Current at Maximum Power point I_{mpp} and Voltage at Maximum Power point V_{mpp} using The constant fill-factor algorithms assume that the MPP voltage is given as a constant fraction of the open circuit module voltage V_{oc} or that the MPP current is given as a constant fraction of the short circuit module current I_{sc} [8]. These fractions are denoted the fill-factors:

$$F.V = \frac{V_{mpp}}{V_{oc}} = 0.8 \tag{3}$$

$$F.I = \frac{I_{mpp}}{I_{sc}} = 0.9 \tag{4}$$

Finally using the equations below to estimate maximum power points at different conditions:

$$R_{MPP} = \frac{V_{mpp}}{I_{mpp}} \tag{5}$$

$$P_{mpp} = V_{mpp} * I_{mpp} \tag{6}$$

3. Work Reign on I-V Curve for Boost Converter

The performance of DC-DC converter depends on the input impedance and the connected load RL. For the boost converter, the selected load resistance (R_L) should be greater than the R_{mpp} ($R_L \geq R_{mpp}$). Further, the tracking region for the boost converter lies below the load line Fig. (1) [9][10]. By changing the duty cycle, the load impedance is matched with the source impedance to attain the maximum power from the PV panel [10]. So the value of this duty cycle is given by [11] :

$$D = 1 - \sqrt{\frac{R_{mpp}}{R_L}} \tag{7}$$

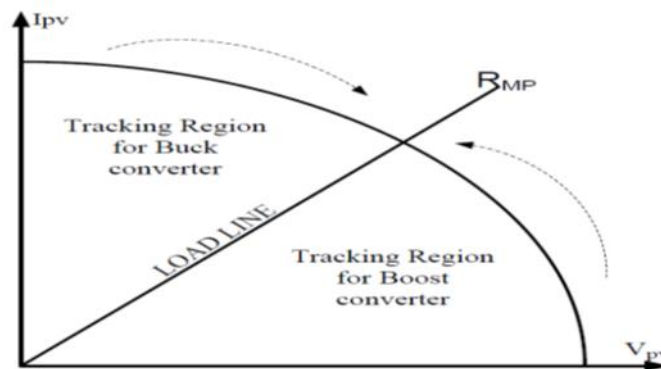

Figure 1: Work reign on I-V curve

4. Design Equation of Boost Converter

4.1 Design equations of boost converter without losses

For a boost converter the output voltage is obtained by equation [2]:

$$V_o = \frac{V_s}{1-D} \tag{8}$$

For continuous conduction mode (CCM) operation, the D value changes from $0 < D < 1$, the inductance is calculated such that the inductor current (I_L) flows continuously and never falls to zero. L_{min} is given by [12][13]:

$$L_{min} = \frac{D(1-D)^2 R_L}{2f_s} \tag{9}$$

where L_{min} is the minimum inductance, R_L is output resistance, and f_s is the switching frequency of switch. [12][13]. The output capacitance to give the desired output voltage ripple is given by [14][15]:

$$C_{min} = \frac{D}{f_s V_r R_L} \tag{10}$$

where C_{min} is the minimum capacitance [12]. And V_r is output voltage ripple factor, V_r can be expressed as [13]:

$$V_r = \frac{\Delta V_o}{V_o} \tag{11}$$

4.2 Design equations of boost converter with losses

The minimum inductance required for CCM operation can be calculated as [14]:

$$L_{min} = \frac{D_{min}(1-D_{min})^2 R_{Lmax}}{2f_s} \tag{12}$$

$$D_{min} = \frac{V_o - V_{Smax} \cdot \eta}{V_o} \tag{13}$$

and the minimum filter capacitance is given by:

$$C_{min} = \frac{D_{max} V_o}{f_s V_{c_{pp}} R_{Lmin}} \tag{14}$$

$$D_{max} = \frac{V_o - V_{Smin} \cdot \eta}{V_o} \tag{15}$$

The MOSFET conduction loss is given by [14]:

$$P_{rDS} = r_{DS} * I_{Srms}^2 \tag{16}$$

$$I_{Srms} = \frac{I_{omax} \sqrt{D_{max}}}{1 - D_{max}} \tag{17}$$

MOSFET switching losses is given by [14]: Assuming that the transistor output capacitance C_o is linear, the switching loss is expressed by:

$$P_{sw} = f_s C_o V_{omax}^2 \tag{18}$$

Diode power losses is given by [14]:

$$P_D = P_{VF} + P_{RF} \tag{19}$$

The diode power loss due to the diode offset voltage VF is:

$$P_{VF} = V_F I_{omax} \tag{20}$$

The diode power loss due to the diode forward resistance RF is:

$$P_{RF} = R_F I_{Drms}^2 \tag{21}$$

$$I_{Drms} = \frac{I_{omax}}{\sqrt{1 - D_{max}}} \tag{22}$$

The inductor power losses is given by [14]:

$$P_{rL} = r_L I_{Lrms}^2 \tag{23}$$

$$I_{Lrms} \approx I_{Imax} = \frac{I_{omax}}{1 - D_{max}} \tag{24}$$

The power loss in the capacitor is:

$$P_{rC} = r_C I_{Crms}^2 \tag{25}$$

$$I_{Crms} = \sqrt{\frac{D_{max}}{1 - D_{max}}} \tag{26}$$

The total power loss is given by [14]:

$$P_{LS} = P_{rDS} + P_{sw} + P_D + P_{rL} + P_{rC} \tag{27}$$

and the converter efficiency at full load is:

$$\eta = \frac{P_{omax}}{P_{omax} + P_{LS}} \tag{28}$$

where, r_{DS} is the MOSFET on-resistance, RF is the diode forward resistance, VF is the diode threshold voltage, r_L is the ESR of the inductor L , and r_c is the ESR of the filter capacitor C [14].

5. Design Calculations

The parameters of the PV module simulated in this paper is adjusted according to a real PV module (KD135SX_UPU PV module) at STC, as given in Table (1).

5.1 Estimating the maximum power point (MPP) under different operating conditions

According to equations (1), (2), (3), (4), (5) and (6), PV-MPP Resistance, Voltage, Current, and Power are calculated under a wide range of operating conditions are given in table (2).

5.2 Design of a boost converter without losses

In this paper, the range of the irradiance levels is selected from (400-1,000) (W/m^2) [1], for the temperature range (25°-60° C). For suitable DC-DC boost design, measures have been taken considering the change of the load impedance (R_L must be greater than R_{mpp}), according to the condition of the boost work area on the I-V curve. The load impedance considered was ($R_L = 3 * R_{mpp}$) [10], under a different operating conditions, as given in Table (3).

The designed boost must have the ability to cover all these changes keeping the operation in CCM and satisfying the requirements of MPPT. According to equations (7 to 11) the calculated parameters of the designed boost without losses, are given in Table (4).

From Table 4, the highest calculated values of L_{min} . and C_{min} . are considered as the minimum chosen values for such design to make the boost able to cover all the possible changes that may occur in irradiance, temperature, and load impedance. So, $L_{min}=1\text{mH}$ and $C_{min}= 50 \mu\text{F}$.

5.3 Design of boost converter with losses

According to equations (12 to 15), the calculated parameters of the designed boost with losses are given in Table (5).

Calculation for power losses and efficiency of boost converter for CCM mode.

The selected MTP 4N50 power MOSFET with $V_{DSS} = 500 \text{ V}$, $I_{SM} = 4\text{A}$, $r_{DS} = 1$, $Q_g = 27 \text{ nC}$, and $C_o = 100 \text{ pF}$. An MUR1560 ultrafast recovery diode is also chosen, with $V_{DM} = 600 \text{ V}$, $I_{DM} = 15 \text{ A}$, $VF = 0.7\text{V}$, and $RF = 17.1 \text{ m}\Omega$ [14]. and $r_L = 0.1\Omega$, $r_c = 0.5\Omega$. By using the given data and applying equations (16 to 26), the parameters and power losses for the proposed boost design are calculated as given in Table (6).

Table 1: The parameters of the PV module Kd135SX_UPU at ST

parameters	value
P_{mpp}	135W
V_{oc}	21.1 V
I_{sc}	8.37 A
V_{mpp}	17.7 V
I_{mpp}	7.63 A
Temperature coefficient of I_{sc}	$0.102 \times 10^{-2} \text{ A/C}^\circ$
Temperature coefficient of V_{oc}	$-0.36099 \times 10^{-2} \text{ V/C}^\circ$

Table 2: PV-MPP calculated under different operating conditions

Irradiance (W/m^2)	Temperature (C°)	R_{mpp} (Ω)	V_{mpp} (V)	I_{mpp} (A)	P_{mpp} (W)
1000	25	27.84	212.4	7.63	1621
400	60	22.69	177	7.8	1380.6
	25	70.56	212.4	3.01	639.324
	60	57	177	3.1	548.7

Table 3: PV-MPP load resistance ($R_L = 3 * R_{mpp}$) under different operating conditions

Case of irradiance (W/m^2)	Temp. (C°)	R_{mpp} (Ω)	R_L (Ω)
1,000	25	27.84	50
			100
	60	22.69	50
			100
400	25	70.56	100
			200
	60	57	100
			200

Table 4: Parameters of the designed boost converter without losses

irradiance W/m^2	Temp. (C°)	R_{mpp} (Ω)	R_L (Ω)	f_s (KH)	V_r	D	V_s (V)	V_o (V)	L_{min} μH	C_{min} μF
1000 W/m^2	25	27.84	50	15	1%	0.2538	212.4	284.6	235.5	33.84
			100			0.4723	212.4	402.5	438.4	31.48
	60	22.69	50	15	1%	0.3263	177	262.7	246.83	43.5
			100			0.5236	177	371.5	396	34.9
400 W/m^2	25	70.56	100	15	1%	0.16	212.4	252.8	376.3	10.66
			200			0.4	212.4	354	960	13.33
	60	57	100	15	1%	0.245	177	234.4	465.5	16.33
			200			0.4661	177	331.5	885.7	15.53

Table 5: Parameters of the designed boost converter with losses

V_{Smax}	V_{Smin}	V_o	D_{min}	D_{max}	I_{Smax}	I_{Smin}	I_{Omax}	I_{Omin}	R_{Lmax}	R_{Lmin}	L_{min}	C_{min}
212.4	177	406	0.475	0.562	7.63	3.09	4	1.35	300.7	101.5	1.3	75

V	V	V	6	6	A	A	A	A	Ω	Ω	mH	μF
---	---	---	---	---	---	---	---	---	---	---	----	----

Table 6: Parameters and power losses for the designed boost

Parameter	Value	Power losses	Value
rDs	1 Ω	P _{rDs}	47 W
r _L	0.1 Ω	P _{sw}	0.067 W
r _c	0.5 Ω	P _{RF}	0.621 W
R _F	0.017 Ω	P _{VF}	2.8 W
C _O	100 pF	P _D	3.421 W
I _{srms}	6.859 A	P _{rL}	5.8 W
I _{Drms}	6.048 A	P _{rC}	0.64 W
I _{lrms}	7.63 A		
I _{crms}	1.134 A		
V _r	4 V		
V _{cpp}	2 V		
V _F	0.7 V		

The total power loss using eq. (27) is given by:

$$P_{LS} = P_{rDs} + P_{sw} + P_D + P_{rL} + P_{rC} = 60W$$

and the converter efficiency at full load using eq. (28) is given by:

$$\eta = \frac{P_{Omax}}{P_{Omax} + P_{LS}} = \frac{1621}{1621 + 60} = 96\%$$

6. Results and Discussion

6.1 Case (1): Simulation results for ($R_L = R_{mpp}$)

The results obtained using the developed (KD135SX_UPU PV module) manufactured by Kyocera, as a string PV array having 12 series modules. The PV array was simulated in MATLAB/SIMULINK with ($R_L = R_{mpp}$) under a wide range of operating conditions. The parameters for this case: input irradiance (1,000-400) W/m², temperature (25°C- 60°C) and ($R_L = R_{mpp}$). Four simulation tests have been made for this case.

Test-1: the parameter values for this test are; (input irradiance 1,000W/m², temperature 25° C) at STC, and ($R_{mpp} = 27.84 \Omega$). Test-2: the parameter values for this test are; (input irradiance 1,000W/m², temperature 60° C) and ($R_{mpp} = 22.69 \Omega$). Test-3: the parameter values for this test are; (input irradiance 400W/m², temperature 25° C) and ($R_{mpp} = 70.56 \Omega$). Test-4: the parameter values for this test are; (input irradiance 400W/m², temperature 60° C) and ($R_{mpp} = 57 \Omega$). The simulation results of these tests are summarized in table (7).

Table 7, shows that the maximum output power at standard irradiance 1,000 W/m², at 25°C equals 1,621 W. The PV produces a maximum output power at the output current = 7.63A and the output voltage = 212.4 V. When the irradiance level decreases to 400 W/m², at 60° C, the maximum output power decreases to 547.4 W. This result occurs at the output voltage = 176.6 V and at output current = 3.099 A. From the results in Table 7, the parameter values for best and worst case are given in Table (8).

6.2 Case (2): Simulation results for ($R_L > R_{mpp}$)

This Case includes a PV array with real load resistance R_L instead of R_{mpp} under different operating conditions. The parameters values for this case: input irradiance (400-1000) W/m², temperature (25-60)° C and ($R_L = 3 * R_{mpp}$). In this case, the efficiency of PV array is calculated without using MPPT algorithm. From Simulink results for case (2), the efficiency of the PV array with respect to MPP values that was calculated in case 1, are given in Table (9).

In Table 9, two criteria are used for computing efficiency of the solar panel system. The first criteria with respect to the standard test conditions (STC). The other criteria is the maximum power obtained from the solar panel at the specified environmental conditions, where for each specific conditions there is a maximum power point where no greater energy can be obtained from them, unless the circumstances have changed. At 1,000 W/m², 25° C max power obtained is 1,621W which considered as max power point for these conditions. When the real load increase for $R_L = 3 * R_{mpp}$, the efficiency decreases by (70-37) % of power at R_{mpp} value. For the same change in load impedance with the same irradiance but temperature rise to (60°C), (1,000 W/m², 60°C) the efficiency decreases from (53-28) % of power at optimal value. This different represent the temperature effect with impedance load changing. Increasing the temperature leads to decreasing the efficiency of the solar panel. So, the new maximum power that can be obtained in these circumstances is (1,411W) instead of (1,621W), when the load changes by ($R_L = 3 * R_{mpp}$), the efficiency decrease from (61-33) % of power at maximum point for these specified conditions. Similarly, for the case of irradiance and temperature (400(W/m²), 25° C), whenever temperature increase to 60° C and load increase by ($R_L = 3 * R_{mpp}$), the efficiency will decrease and measured relative to maximum power point at those specific environmental conditions.

6.3 Case (3): Simulation results with MPPT(P&O) controller

The purpose of this case is to enhance the system efficiency by using MPPT (P&O) controller. The Simulink model includes; PVG, Boost Converter, MPPT (P&O) controller, and Load as shown in Figure (2).

Table 7: Simulation results of PV-MPP under different operating conditions

Irradiance (W/m ²)	Temp. (C°)	R _{mpp} (Ω)	V _{mpp} (V)	I _{mpp} (A)	P _{mpp} (W)
1000	25	27.84	212.4	7.63	1621
	60	22.69	178.7	7.877	1408
400	25	633.7	211.5	2.997	633.7
	60	547.4	176.6	3.099	547.4

Table 8: Maximum and minimum PVG power

Irradiance and temperature	I _{pv} (A)	V _{pv} (V)	P _{pv} (W)
1000W/ m ² at 25°C	7.63	212.4	1621
400W/ m ² at 60°C	3.09	177	547.4

Table 9: Efficiency of PV array with both environmental conditions and load impedance changes without tracking

irradiance (W/m ²)	Temp. (C°)	R _L (Ω)	P _{pv} (W)	Efficiency (p.u)	Efficiency with respect to STC (p.u)
1000	25	50	1135	0.7	0.7
		100	607.6	0.37	0.37
400	60	50	867.1	0.61	0.53
		100	462.8	0.33	0.28
	25	100	519	0.81	0.32
		200	281.5	0.44	0.17
60	100	390.1	0.71	0.24	
	200	209.8	0.38	0.13	

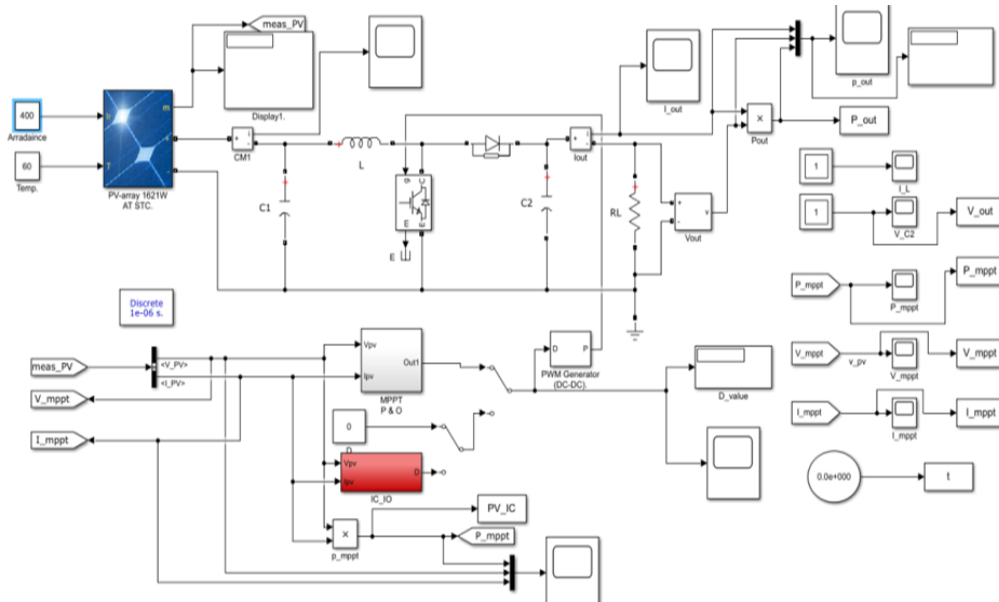

Figure 2: Simulink model for (PVG, boost converter, MPPT, and R_L)

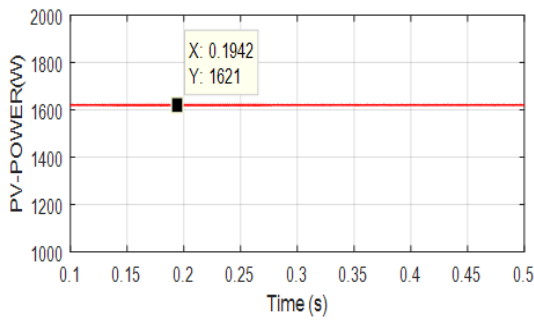

Figure 3: P_{pv} @ $1000W/m^2, 25^\circ C$ $R_L(50\Omega)$

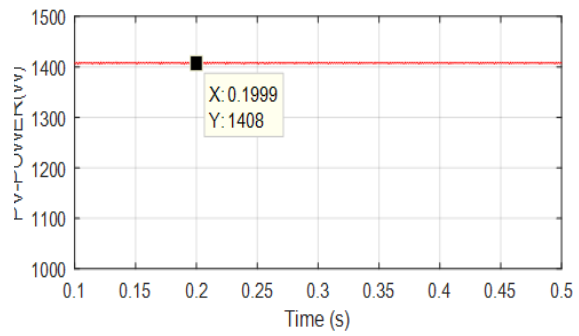

Figure 4: P_{pv} @ $1000W/m^2, 60^\circ C$ $R_L(50\Omega)$

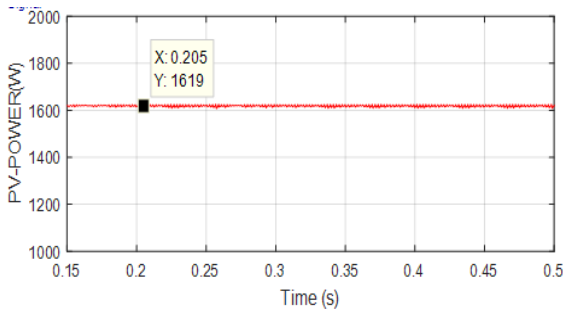

Figure 5: P_{pv} @ $1000W/m^2, 25^\circ C$ $R_L(100\Omega)$

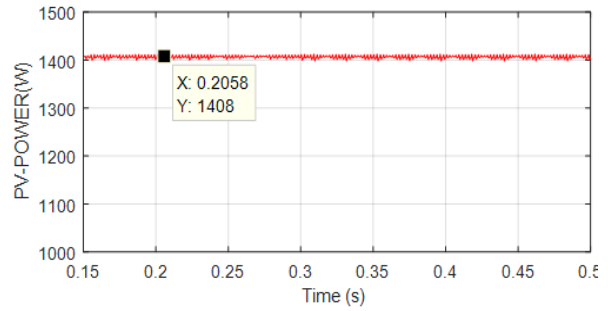

Figure 6: P_{pv} @ $1000W/m^2, 60^\circ C$ $R_L(100\Omega)$

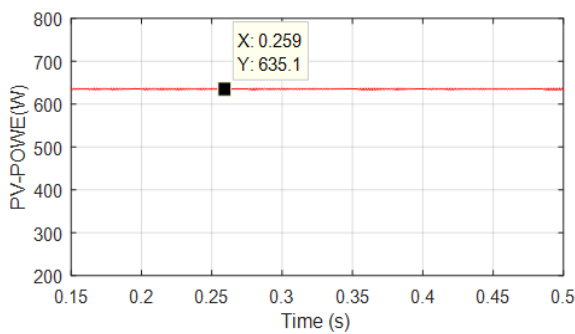

Figure 7: P_{pv} @ $400W/m^2, 25^\circ C$ $R_L(100\Omega)$

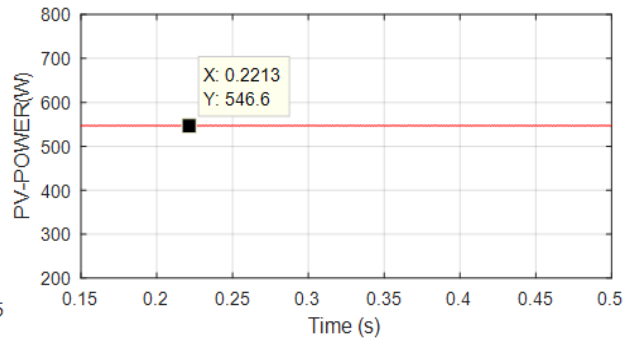

Figure 8: P_{pv} @ $400W/m^2, 60^\circ C$ $R_L(100\Omega)$

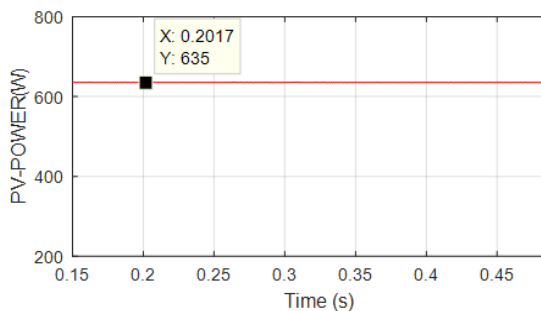

Figure 9: P_{pv} @ $400W/m^2, 25^\circ C$ $R_L(200\Omega)$

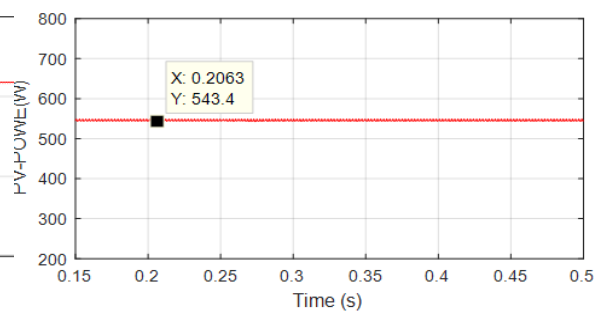

Figure 10: P_{pv} @ $400W/m^2, 60^\circ C$ $R_L(200\Omega)$

Table 10: The efficiency enhancement after using tracking (P&O) method

Irr. /temp.	R_L	D	P_{pv} (W)	V_{pv} (V)	I_{pv} (A)	Efficiency (p.u)	Efficiency (p.u) Without tracking	P_{out} (W)
1000 W/ m ² , 25° C	27.84 R_{mpp}	0	1,621	212.4	7.63	1	1	
	50	0.245	1,620	212.3	7.63	0.99	0.7	1,555.2
	100	0.4545	1,619	212.6	7.615	0.99	0.37	1,554.2

1000 W/ m ² , 60° C	22.69 R_{mpp}	0	1,411	178.9	7.884	1	1	
	50	0.3155	1,408	179.8	7.82	0.99	0.61	1,351.7
	100	0.5	1,407	179.9	7.825	0.99	0.33	1,350.7
400 W/ m ² , 25° C	70.56 R_{mpp}	0	635.7	211.5	2.997	1	1	
	100	0.1624	635	208	3.057	0.99	0.81	610.4
	200	0.378	635	207.7	2.935	0.99	0.44	606
400 W/ m ² , 60° C	57 R_{mpp}	0	547.4	176.6	3.099	1	1	
	100	0.2391	546.1	174.5	3.132	0.99	0.71	524.2
	200	0.443	543.4	174.5	3.1	0.98	0.38	521.6

The simulation results are explained in Figures (3 - 10) and Table 10. The simulation results includes eight tests, the same as given in case #2.

Comparing the results of case (#3) with results in case (#1) and (#2), the efficiency enhancement after using tracking (P&O) method at PV array side, are summarized in Table (10) rather than the out power with boost losses consideration.

The efficiency on PV side improved from (98-99) % in all cases. At 1,000 W/m², 25° C, load (50-100) Ω, the value of PV array voltage after tracking is (212.3-212.6) V near to reference value (212.4V). At 1,000 W/m², 60° C, load (50-100) Ω, the value of PV array voltage is (179.8-179.9) V near to reference simulation value 178.9 V. At 400W/m², 25° C, load [100-200] Ω, the value of PV array voltage is (208.3-207.7) V near to reference value (212 V). At 400 W/m², 60° C, load (100-200) Ω, the value of PV array voltage is 174.5 V near to reference value 177V.

7. Conclusion

The designed PV generator with its MPPT controller achieved good agreement between the analytical and the simulation results under various irradiation and temperature levels. In the case of supplying various load resistance values, the efficiency of the PV generator has been improved with increasing the irradiance levels, while the efficiency decreased with increasing temperature. The calculated and simulation results are in good agreements and the maximum efficiency of the implemented MPPT algorithm is about 99%.

Author contribution

All authors contributed equally to this work.

Funding

This research received no specific grant from any funding agency in the public, commercial, or not-for-profit sectors.

Data availability statement

The data that support the findings of this study are available upon request from the corresponding author.

Conflicts of interest

The authors declare that there is no conflict of interest.

References

- [1] A. J. Mahdi, Design And Performance Analysis Of An On-Grid Photovoltaic Power System Under Iraqi Solar Circumstances, *J. Eng. Sustain. Dev.*, 21, 4, (2017), 46–57.
- [2] A. J. Mahdi, S. Fahad, and W. Tang, An Adaptive Current Limiting Controller for a Wireless Power Transmission System Energized by a PV Generator, *Electronics*, 9, 10, (2020), 1648.
- [3] H. Mamur and R. Ahiska, Application of a DC–DC boost converter with maximum power point tracking for low power thermoelectric generators, *Energy Convers. Manag.*, 97, (2015), 265–272.
- [4] B. Nayak, A. Mohapatra, and K. B. Mohanty, Selection criteria of dc-dc converter and control variable for MPPT of PV system utilized in heating and cooking applications, *Cogent Eng.*, 4, 1, (2017), 1363357.
- [5] A. Pradhan and B. Panda, A simplified design and modeling of boost converter for photovoltaic system, *Int. J. Electr. Comput. Eng.*, 8, 1, (2018), 141.
- [6] A. Chouder, S. Silvestre, N. Sadaoui, and L. Rahmani, Modeling and simulation of a grid connected PV system based on the evaluation of main PV module parameters, *Simul. Model. Pract. Theory*, 20, 1, (2012), 46–58.
- [7] A. Guerra Vega, Designing a Solar PV System to Power a Single-Phase Distribution System, (2019).
- [8] S. B. Kjær, *Design and control of an inverter for photovoltaic applications*. Institute of Energy Technology, Aalborg University, (2005).
- [9] H. Al-Bahadili, H. Al-Saadi, R. Al-Sayed, and M. A.-S. Hasan, Simulation of maximum power point tracking for photovoltaic systems, in *2013 1st International Conference & Exhibition on the Applications of Information Technology to Renewable Energy Processes and Systems*, (2013), 79–84.
- [10] D. Choudhary and A. R. Saxena, Incremental conductance MPPT algorithm for PV system implemented using DC-DC buck and boost converter, *Int. J. Eng. Res. Appl.*, 14, (2014), 123–132.
- [11] O. P. Mahela and A. G. Shaik, Comprehensive overview of grid interfaced solar photovoltaic systems, *Renew. Sustain. Energy Rev.*, 68, (2017), 316–332.

- [12] S. Fahad, A. J. Mahdi, W. H. Tang, K. Huang, and Y. Liu, Particle swarm optimization based dc-link voltage control for two stage grid connected pv inverter, in *2018 International Conference on Power System Technology (POWERCON)*, (2018), 2233–2241.
- [13] P. W. Chan, DC-DC boost converter with constant output voltage for grid connected photovoltaic application system, in *Industrial Electronic Seminar*, (2010).
- [14] M. K. Kazimierczuk, *Pulse-width modulated DC-DC power converters*. John Wiley & Sons, (2015).
- [15] I. Batarseh and A. Harb, *Power Electronics*. Springer, (2018).